

Cambridge Pre-Packaged/ Pre-Cut MaytRx Wall Fireplace Instruction Manual

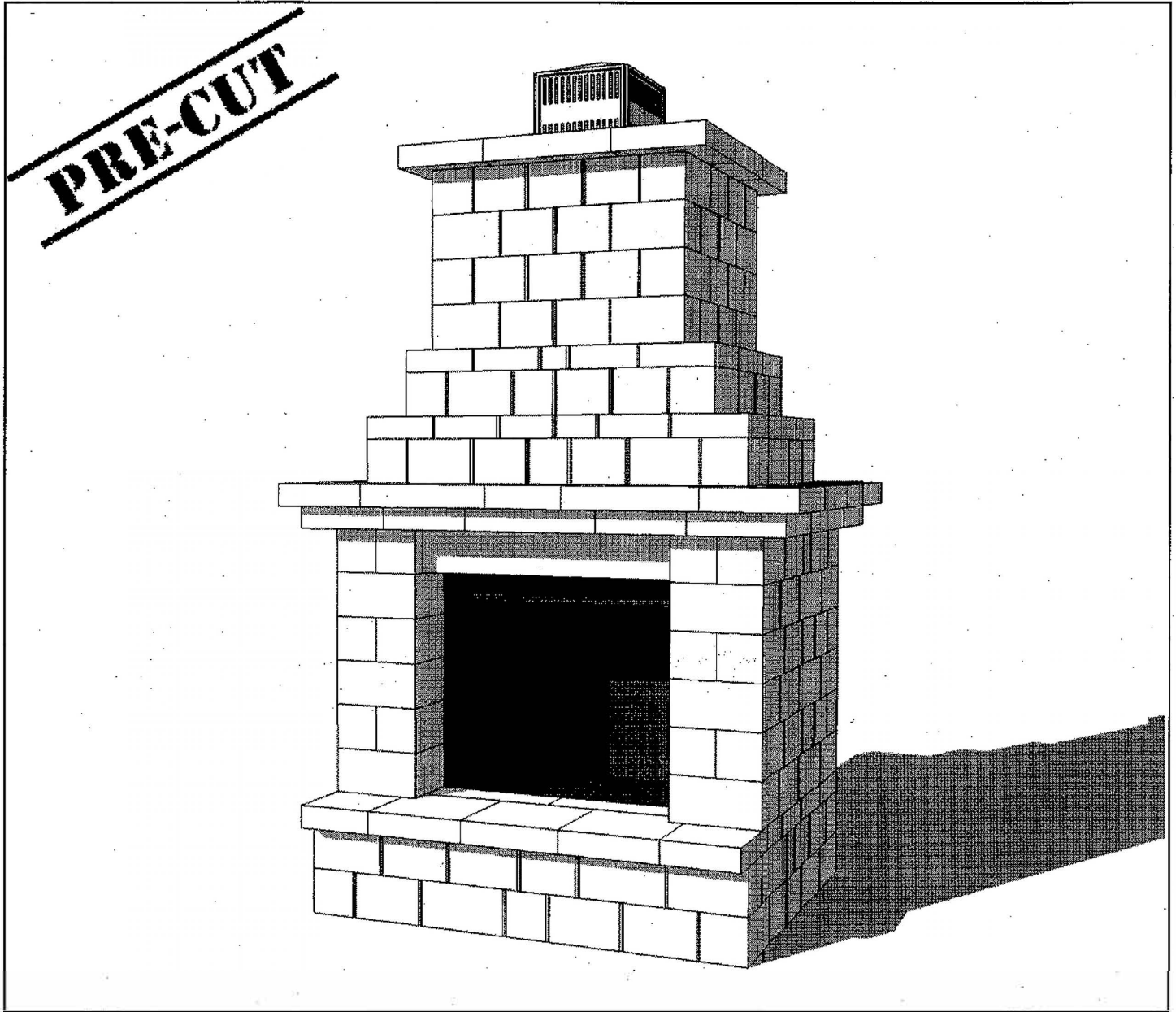

**Cambridge Pre-Envasados/Pre-Cortado
MaytRx Kit Pared de la Chimenea al Ai-
re Libre**

PRE-CUT

Cambridge Pre-Packaged/ Pre-Cut MaytRx Fireplace Kit

2024

Layer Reference Guide:

Guia de Referencia:

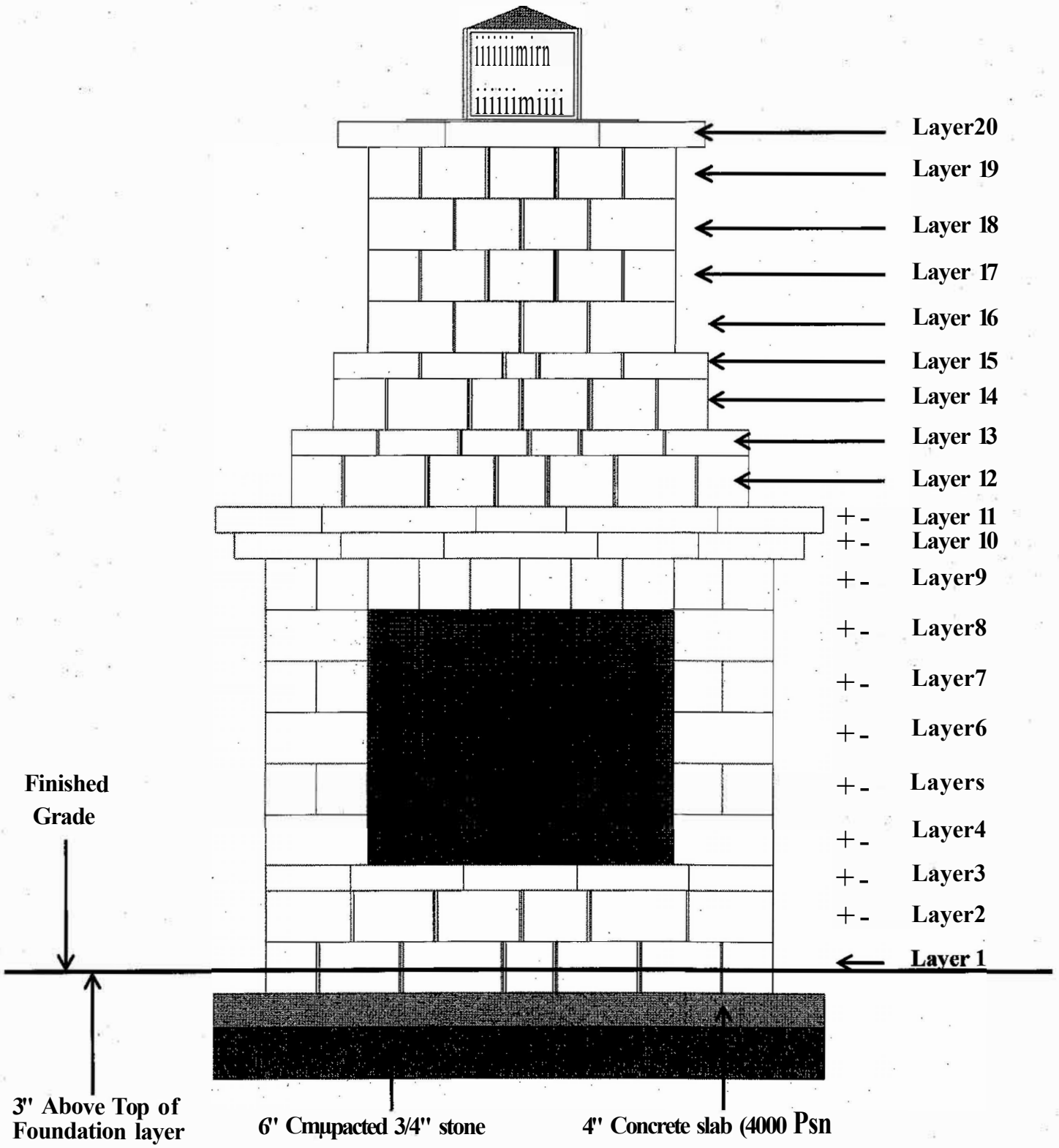

PRE-CUT

Cambridge Pre-Packaged/ Pre-Cut MaytRx Fireplace Kit

2024

Cambridge Fireplace:

This unit is capable of burning natural gas, propane and wood. If either propane or natural gas is the preferred method of burning, seek a licensed professional to construction. Also, if using propane or natural gas, a knockout is located on either side of the unit to facilitate gas piping. All piping and knockouts must be completed before installing blocks around unit as the unit will become inaccessible when construction is completed.

*NOTE: The Fireplace Installation Manual supplied with this kit is for a house interior installation which as per does not apply for this application except for installation of air-cooled chimney as shown in step 4.

**NOTE: Air-Cooled Chimney extensions are available in 1', 2', & 4' lengths. Call your Cambridge Distribu-tor for pricing and availability.

Tools required for Fireplace Kit Installation:

Safety Goggles
Ear Protection
Dust Mask
Gloves
Shovels (digging & flat)
Metal Cutters for banding on cubes
Mason Hammer (chipping, hammer)
Road Stone Rake
Tamper (Hand or Mechanical)
Wheelbarrow
(Level (2' and 6' recommended)
Speed Square
Caulk Gun 10 oz or 28 oz (depends on what size adhesive is purchased)
Rubber Mallet
14" Demo saw with diamond blade
Tape Measure
Marking Device (pencil, soap stone, etc)
Chalk Line
Hand Broom
Concrete Tools (Trowel/Floats)
6 Foot ladder or scaffold according to your company's state, and OSHA safety policy
Drill & 1/16" bit
5/16" nut driver
7 1/4" Circular saw with wood blade
Phillips screwdriver
7 1/2" Electric grinder
7 1/2" Diamond cup grinder

Material Required:

3/4" clean stone (approx. 1 ton)
Concrete (approx. 15-50lb bags)
(4) concrete tubes 8' x 36" long
Concrete adhesive (approx. 6-29 oz. or 17-10.3 oz. tubes)
(4) pieces of 2" x 4" x 8" lumber
2 1/2" wood screws
1/2" rebar (approx. 12")
Silicone for flashing

Items included in the Fireplace Kit:

(1) Stainless Steel Fireplace with instruction manual*
(1) Four (4) foot air-cooled chimney**
(1) Galvanized flashing for top of completed fireplace
(2) Reinforced concrete lintels 48 1/2" x 3 5/8" x 5 7/8"
(3) Plastic shim pack sheets for leveling lintels or block as needed
(4) Cubes of Cambridge Maytrx Wall
(1) Installation manual for concrete pad and Cambridge Maytrx WaU

PRE-CUT

Cambridge Pre-Packaged/ Pre-Cut MaytRx

Fireplace Kit

2024

Chimenea de Cambridge:

Esta unidad es capaz de quemar gas natural, propano, y la madera. Si bien el propano o el gas natural es el método preferido de la quema, buscar un profesional con licencia para la construcción. Asimismo, si utiliza gas propano o gas natural, un golpe de gracia se encuentra a ambos lados de la unidad para facilitar la tubería de gas. Todas las tuberías y los golpes de gracia debe ser completado antes de instalar los bloques alrededor de la unidad como la unidad se convertirá en inaccesibles cuando se complete la construcción.

*Note: (Adiciones para la caja para la lena) Hay que hacer cojines de concreto para cada adición.

Herramienta Reguerida Para la Instalación del Kit:

Gafas de seguridad
Protección auditiva
Máscara de polvo
Guantes
Palas (excavación y plano)
Cortadores de Metal de bandas en los cubos
Mason Hammer (astillado, martillo)
Camino del rastrillo de Piedra
Sabotaje (manual o mecánica)
Carretilla
Nivel (2' y 6' recomendado)
Velocidad de la Plaza
Pistola para calafatear 10 oz. o 28 oz. (depende de que tamaño es comprar pegamento)
Martillo de goma
14" Demo sierra con disco de diamante
Cinta métrica
Dispositivo de marcado (lapiz, piedra jabón, etc)
Línea de tiza
Escoba de mano
Herramientas concretas (paleta / flotadores)
6 pies escalera o andamio de acuerdo al estado
Taladro y 1/16" bits
5/16" Tuerca conductor
7 1/4" Sierra circular con hoja de madera
7 1/2" Amoladora eléctrica
7 1/2" Amoladora de la taza del diamante
Destornillador Phillips

Material Reguerido:

3/4" Piedra limpia (aprox 1 tonelada)
Concreto (aprox. 15-bolsas de 80 libras)
(4) Tubos de hormigón de 8x36" de largo
Cambridge concretas adhesivo (aprox. 6-29 oz. o 17-10.3 oz. Tubos)
(4 piezas) de 2" x 4" x 8' de madera
2 1/2" tornillos para madera
1/2" Barra de refuerzo (aprox. 12")
Silicona para el flasheo

Artículos Incluidos en el Kit de la Chimenea:

1 - de acero inoxidable de chimenea con manual de instrucciones
1 - 4 pies chimenea enfriado por aire
1 - Polvo Negro tapa de terminación de cubierta
1 - Galvanizado intermitente para la tapa de la chimenea completa
(2) dinteles del concreto reforzado 48" x 3 5/8" x 5 7/8"
3 - Cuija de plástico boja de paquete para nivelar dinteles o bloquear cuando sea necesario
4- Cubos de MaytRx Pared
1 - Manual de instalación para la plataforma de concreto y MaytRx pared

Fireplace Concrete Pad Construction

Call 811 for information on underground utility marking. Select desired location and excavate 68" L x 54" W x 13" D area for concrete pad. Install four 8" diameter concrete tubes to frost-line as per local code. Fill excavated area with approximately 6' of $\frac{3}{4}$ " clean gravel, compacting every 3". (Do not fill concrete tubes with gravel). Frame remaining 4" with 2" x 4" lumber to create a level pad. (Be sure 2"x4" wood frame is perfectly level, front to back and side to side) See attached drawing for details of steel reinforcement rod placement. Fill concrete tubes and 2" x 4" wood frame with a 4,000 psi strong concrete mix.

*Allow pad to cure for minimum of 48 hours

Construccion Concreta del Cojín de la Chimenea:

Llame al 811 para obtener informacion sobre la utilidad de metro marcado. Seleccione la ubicacion deseada y excavar 68" de largo x 54" W x 13" D area de plataforma de concreto. Instale cuatro 8" de diametro de los tubos de hormigon a las heladas-line como por el codigo local. Llene la zona excavada con aproximadamente 6' de $\frac{3}{4}$ " limpia grava, compactando cada 3". (No llene los tubos de concreto con grava). Marco restantes 4" con 2" x 4" de madera para crear una plataforma de nivel. (Asegurese de 2"x 4" marco de madera esta perfectamente horizontal, de adelante hacia atras y de lado a lado) Veanse los detalles del dibujo para la colocacion de varillas de acero de refuerzo. Relleno de concreto y tubos de 2"x 4" marco de madera con una mezcla de concreto 4000 PSI fuerte.

* Deje que la almohadilla para curar por un minimo de 48 horas.

Fireplace Concrete Pad Detail-Cross Section Drawing:
Concreta del cojin de la chimenea detail-Dibujo Transversalmente:

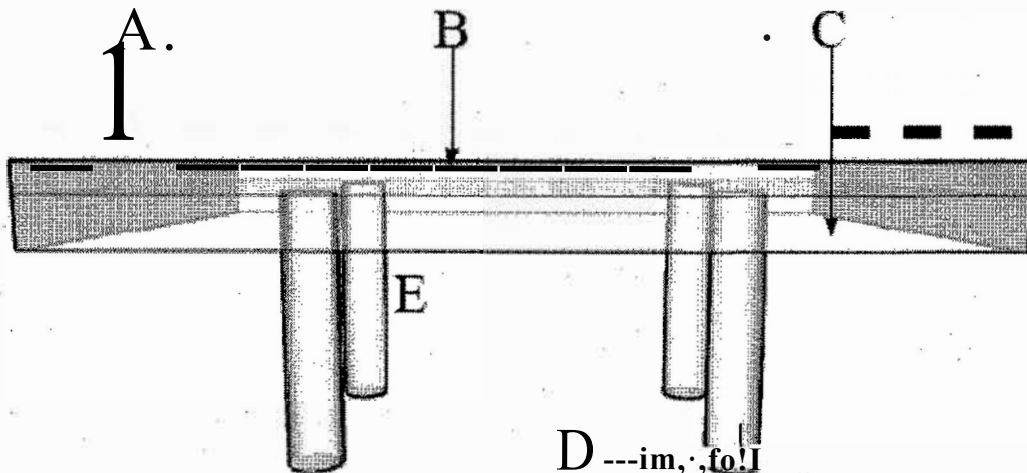

- A. 1/2" steel reinforcing rod / Barra de refuerzo de acero
- B. 4" concrete slab / Bloque de cement de
- C. 6" of 3/4 clean stone / 6" de 3/4 grave limpia
- D. To frostline as per local code / al frostline segun codigo local
- E. 8" concrete sonotubes / 8" de sonotubes de concreto

Top View-Footing Detail/ Vision Superior-Detaile De Pie

- A. 8" concrete sonotubes / 8" de sonotubes de concreto

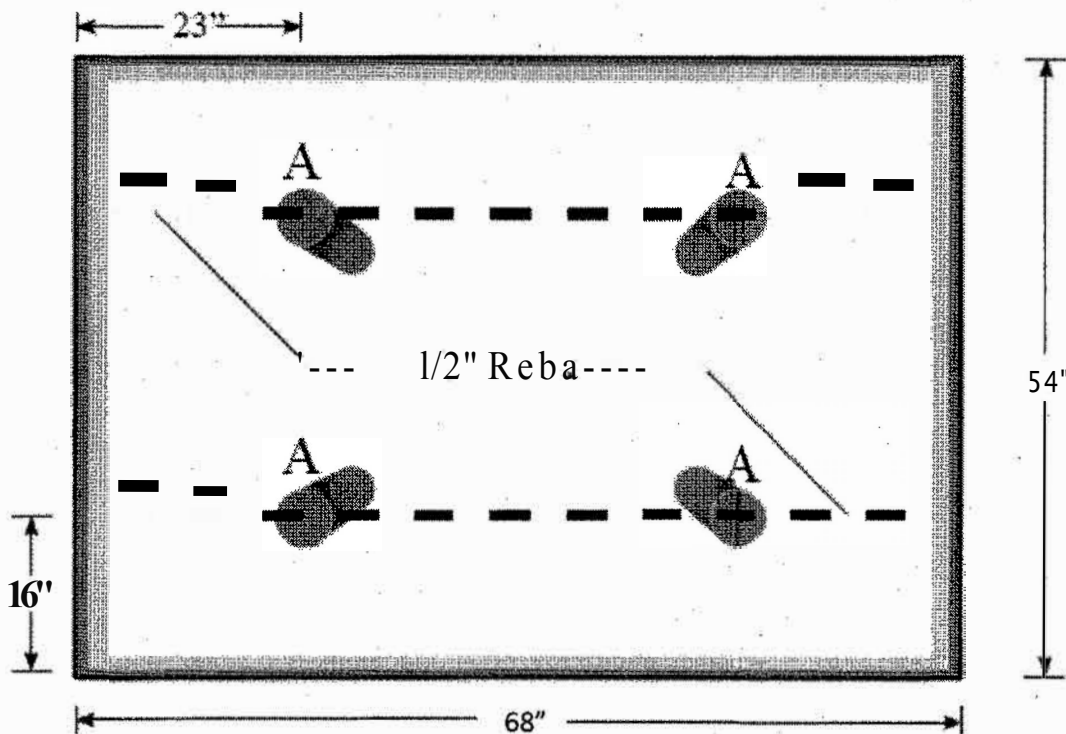

PRE-CUT

Cambridge Pre-Packaged/ Pre-Cut MaytRx Fireplace Kit

2024

MaytRx 3" Stones and cuts:

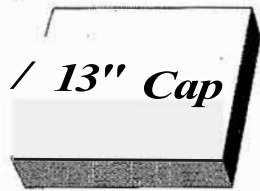

13" Cap (4 Pieces)

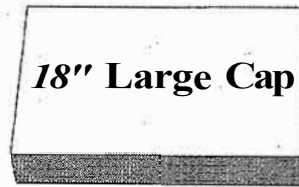

18" Large Cap (8 Pieces)

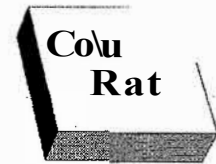

Column Hat (10 Pieces)

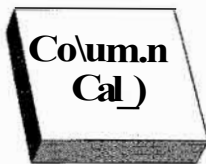

Column Cap (14 Pieces)



6"x8" Cut Y Stone (2 Pieces)



MaytRx X Stone (6 Pieces)

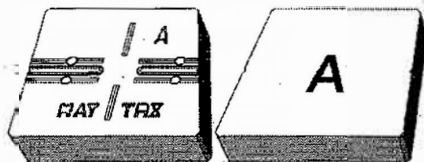

MaytRx A Stone (5 Pieces)

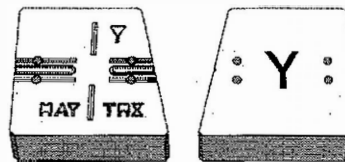

MaytRx Y Stone (7 Pieces)



MaytRx B Stone (8 Pieces)

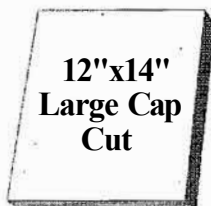

12"x14" Large Cap Cut (2 Pieces)

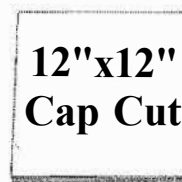

12"x12" Cap Cut (2 Piece)

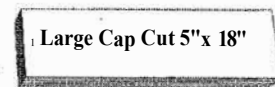

5"x18" Large Cap Cut (2 Pieces)

PRE-CUT

Cambridge Pre-Packaged/ Pre-Cut MaytRx Fireplace Kit

2024

MaytRx 3" Stones and cuts:

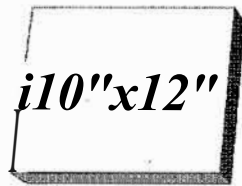

10"x12" Cut Stone (2 Pieces)

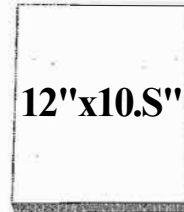

12"x10.5" Cut Stone (2 Pieces)

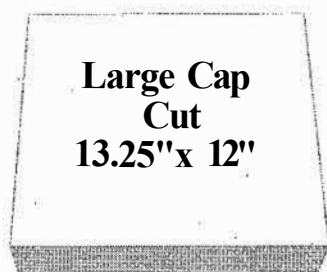

Large Cap Cut 13.25"x 12" (3 Pieces)

PRE-CUT

Cambridge Pre-Packaged/ Pre-Cut MaytRx Fireplace Kit

2024

6" x 4" x 48 1/2" Lintel

6"x4"x48 1/2" Lintel (2 Pieces)

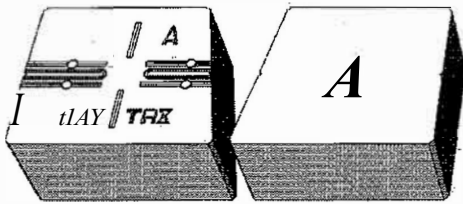

MaytRx A Stone (33 Pieces)

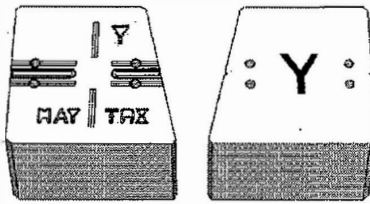

MaytRx Y Stone (46 Pieces)

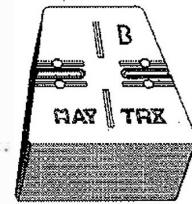

MaytRx B Stone (40 Pieces)

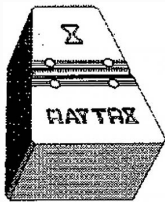

MaytRx X Stone (50 Pieces)



6"x8" Cut Corner Stone (4 Pieces)



8"x12" Special Stone (6 Pieces)



Corner Stone 6"x 10" (50 Pieces)

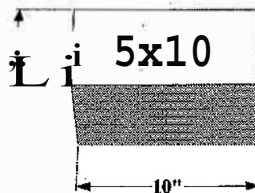

5"x10" Cut Stone (6 Pieces)

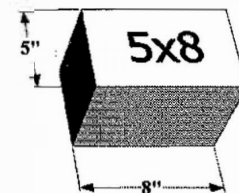

5"x8" Cut Stone (2 Pieces)



2"x6" Cut Stone (2 Pieces)

Special Cuts

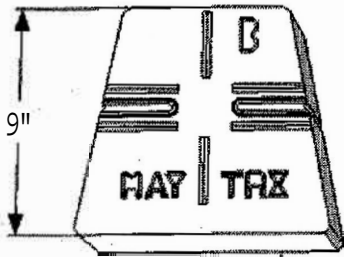

3" B Stone with 1"
cut from small side
2 each
Layer 3

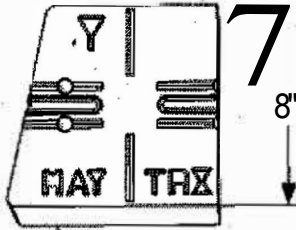

1 Y Stone with 2" cut from
big side and 1 1/2" cut
from square side
2 Each
layer 3

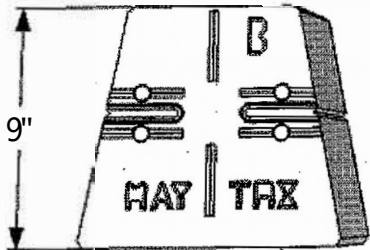
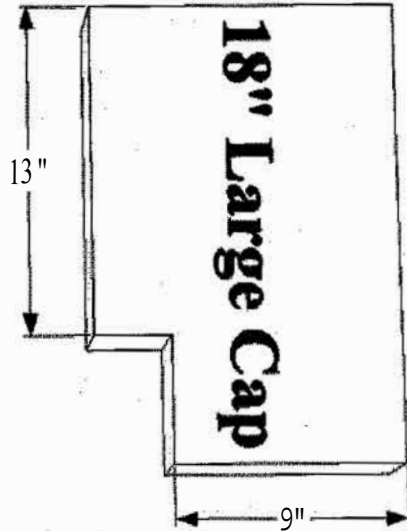

6" B Stone with 1"
cut from small side
6 each

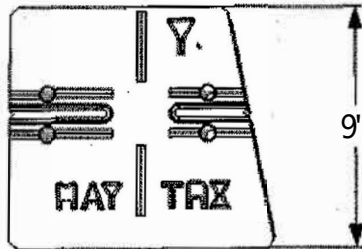

6" Y stone with 1"
cut from small side
6 each

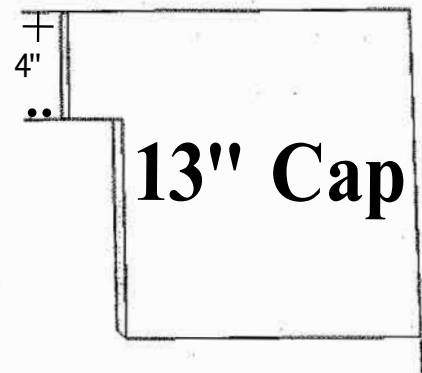

11"

All MaytRx Stones are 10" deep the stones shown above are all cut down from 10" to 9" or 8" depending on where they are used in the kit. Pay close attention to the piece counts and layout for each layer. The 18" Lg Cap are in layer 10. The 13" cap are in layer 11. The 3" Y and B stones are in Layer 3. the 6" Y and B stones are used in layers 3 through 9.

PRE-CUT

Cambridge Pre-Packaged/ Pre-Cut MayRx Fireplace Kit

2024

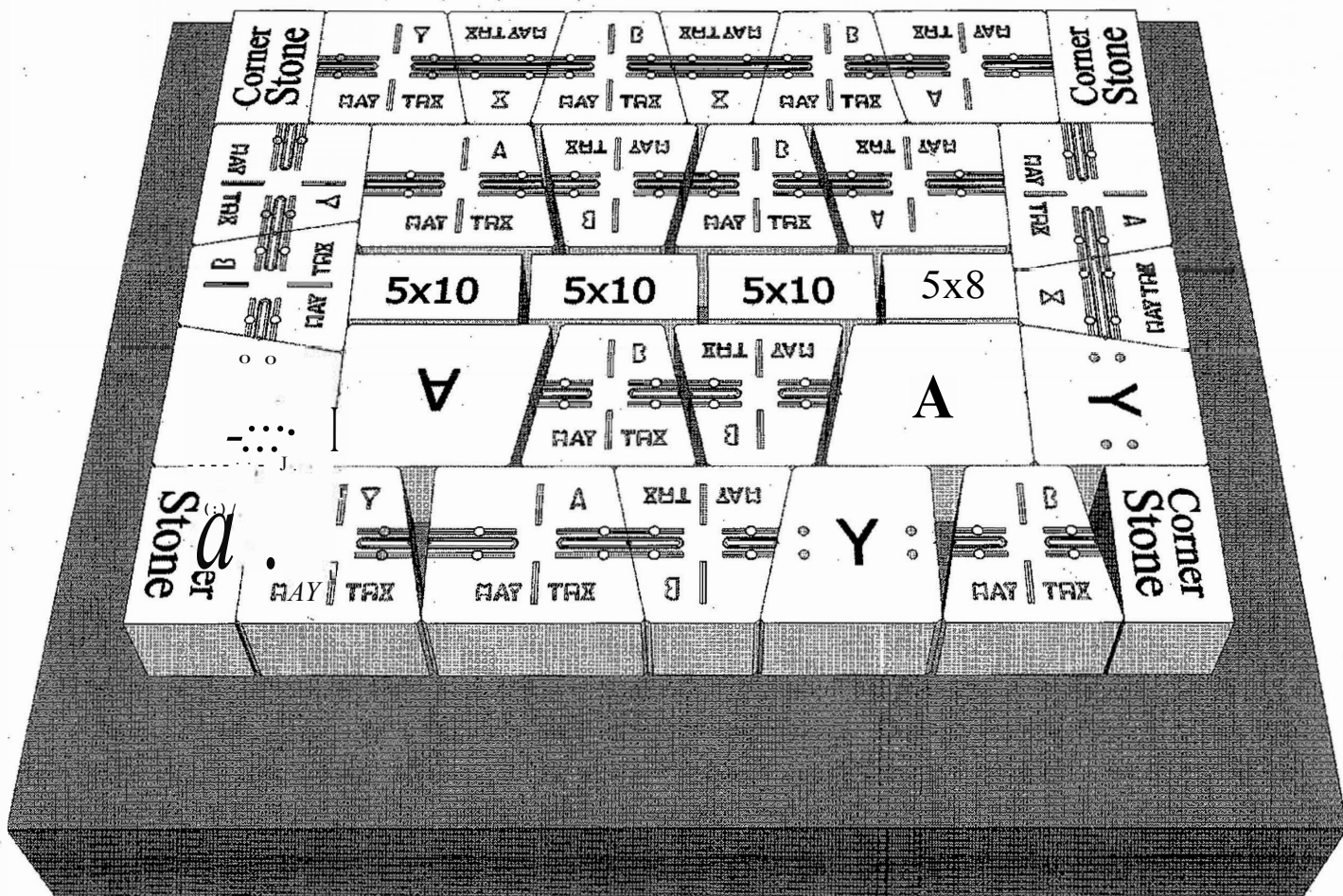

Layer 1:

Piece Count= (7) A, (9) B, (3) X, (6) Y, (4) 6"x10" Corner stones, (3) 5"x 10" Cut stones, (1) 5"x 8" Cut stone

Mark a line 4" in on all four sides of the concrete pad to mark the outside perimeter of fireplace. Apply concrete adhesive and install wall stones and cut stones according to the photo.

Keep all lines straight and corners square.

*Take note during the installation wall stones are installed with either the topside up or the bottom side up depending on their position in the build.

Capa 1:

Numero de Piezas = (7) A (9) B (3) X (6) Y, (4) 6"x10" Esquinas, (3) 5"x 10" Piedras cortadas, (1) 5"x 8" Piedra cortada

Marque una línea 6" adentro en izquierdo y derecho en el cojin concreto y 7" adentro en frente y de nuevo a marca el perimetro exterior de la chimenea. Aplique el pegamento concreto e instalelo por la foto demostrada en detalle de la capa 1. Mantenga todas las líneas cuadrado recto y de las esquinas. Tome la nota durante las piedras de la pared de la instalacion estan instalados con la superestructura para arriba o el lado inferior para arriba dependiendo de su posicion en la estructura.

PRE-CUT

Cambridge Pre-Packaged/ Pre-Cut MayRx Fireplace Kit

2024

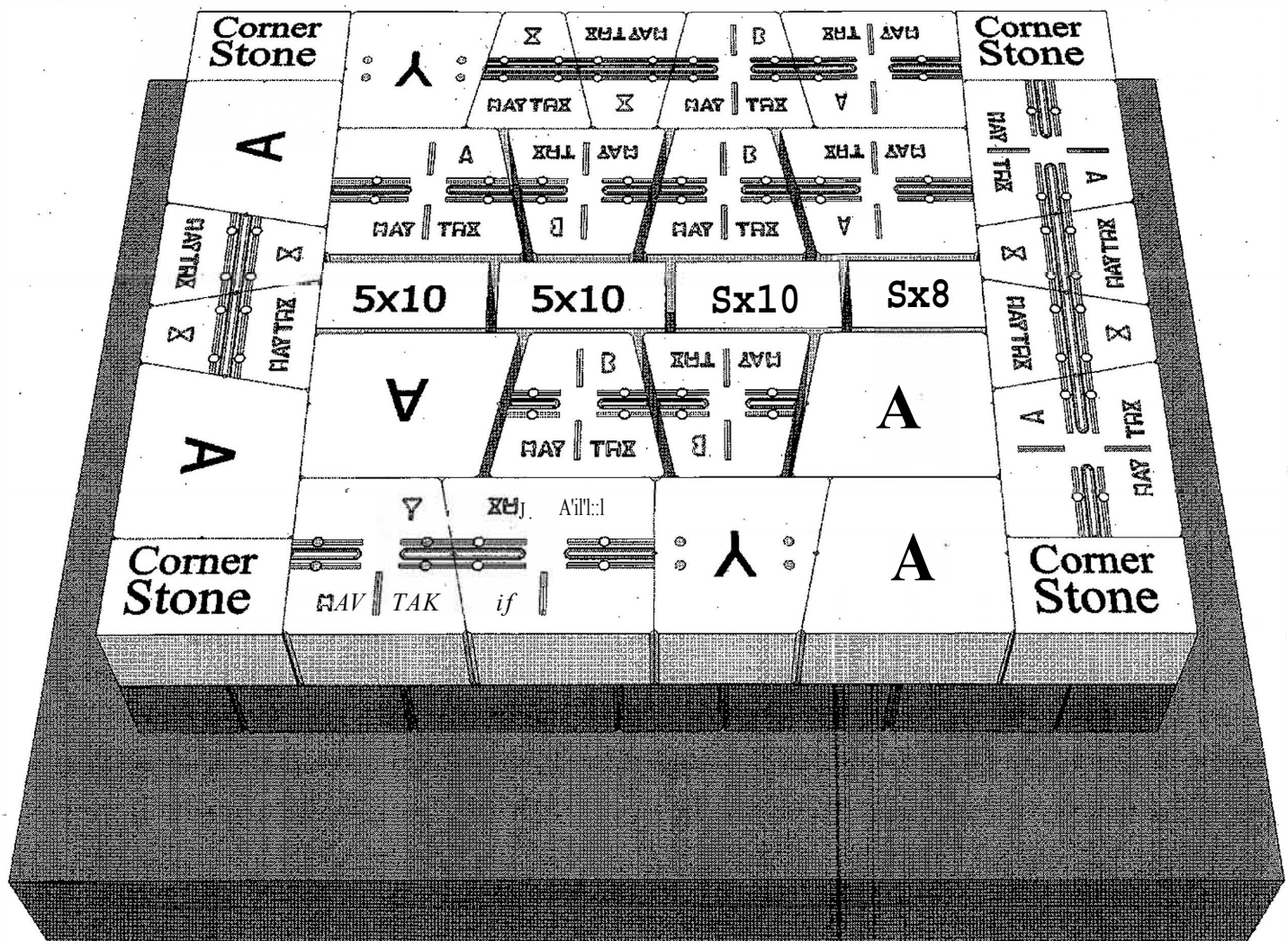

Layer 2:

Piece Count= (11) A, (5) B, (6) X, (3) Y, (4)
6"x10" Corner stones, (3) 5"x 10" Cut stones, (1)
5"x 8" Cut stone

Apply concrete adhesive and install wall stones
and cut stones according to the photo.

Capa 2:

Numero de Piezas = (11) A (5) B (6) X (3) Y (4)
6"x10" Esquinas, (3) 5"x 10" Piedras cortadas,
(1) 5"x 8" Piedras cortadas

Aplique el pegamento concreto e instalelo por la
foto.

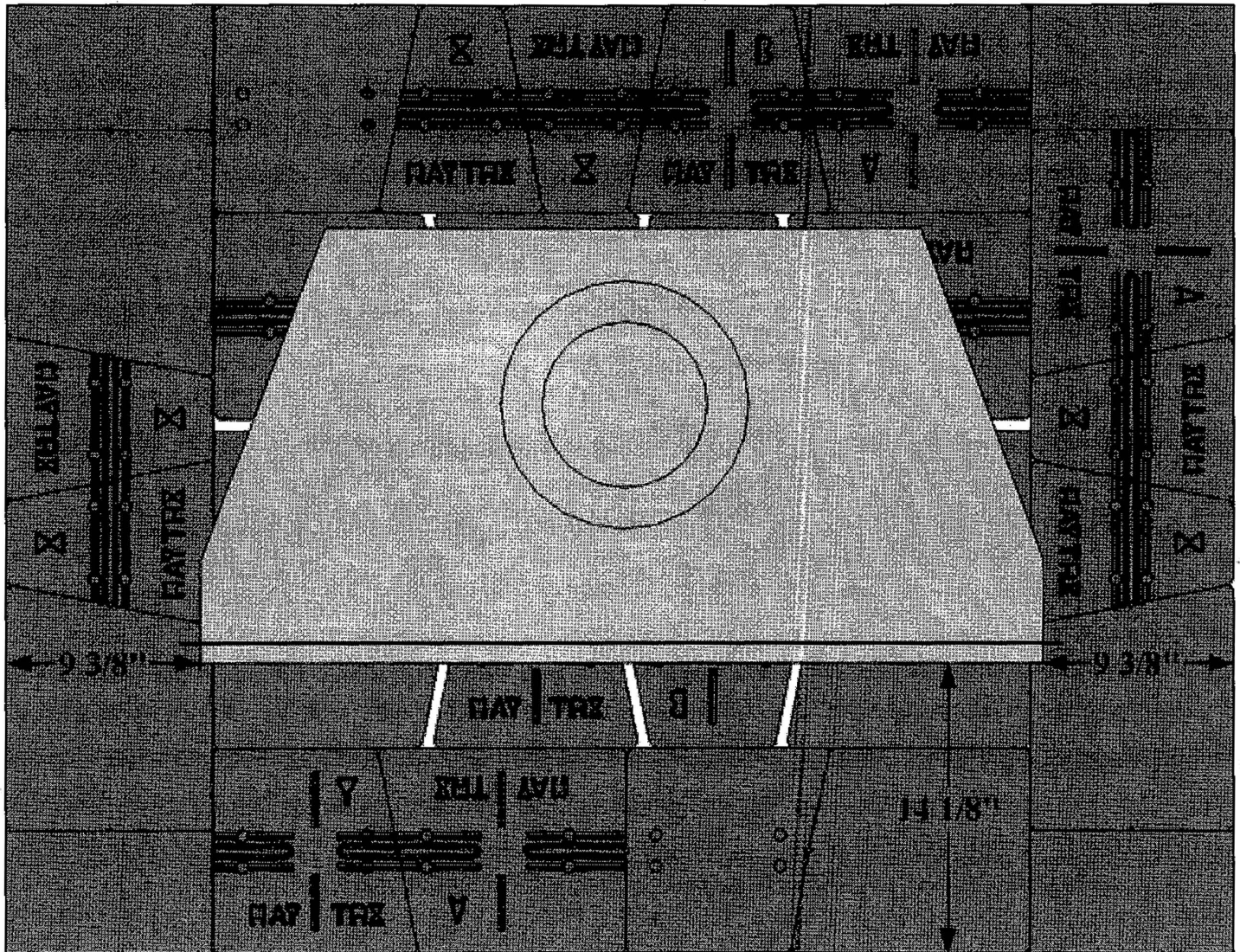

Layer 2-A: Firewood box placement

Install firebox unit 14 1/8" from the front of layer 2 and 9 3/8" in on left and right side. Install chimney to firebox per manufacturer's specifications.

Capa 2-A: Colocacion de la caja de la leña

Instate la unidad 15" de la caja de fuegos del frente de la capa 2 y 10" adentro en lado izquierdo y derecho. Instate la chimenea a la caja de fuegos por las especificaciones del fabricante.

PRE-CUT

Cambridge Pre-Packaged/ Pre-Cut MaytRx Fireplace Kit

2024

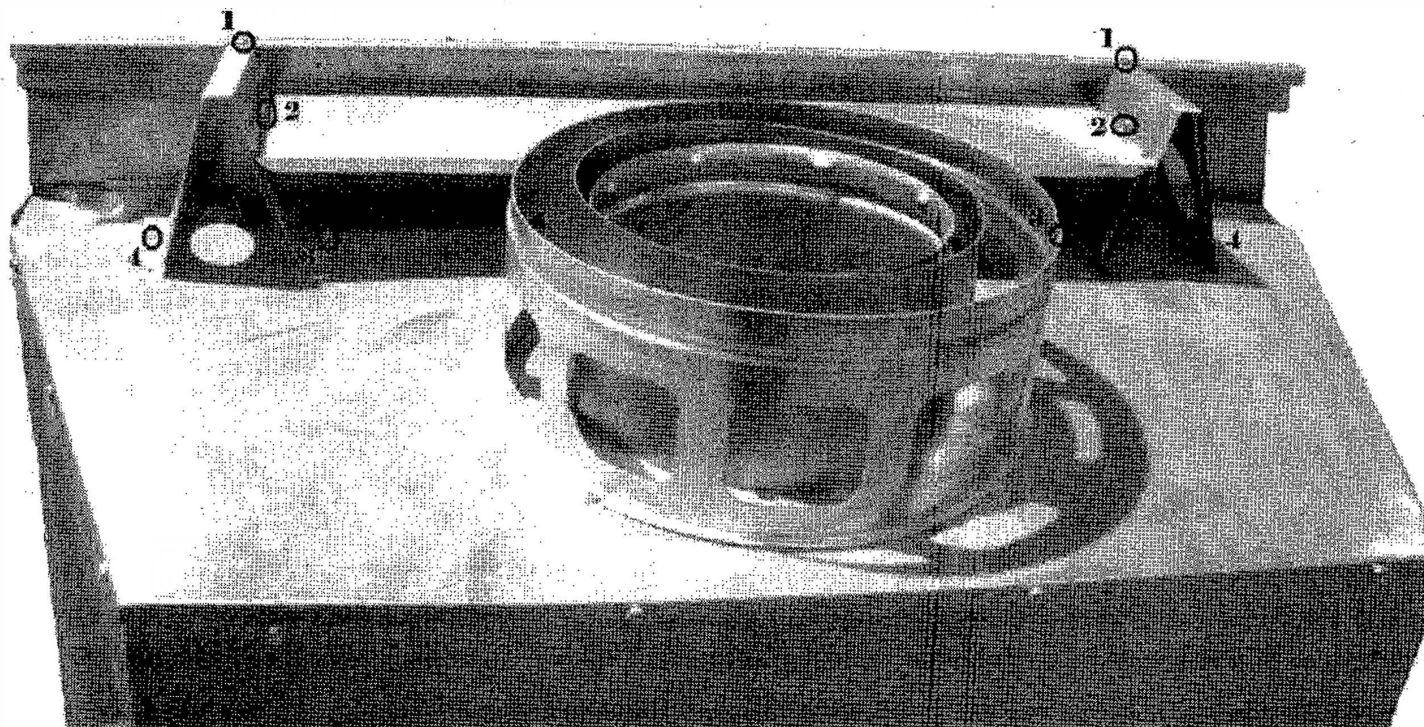

Layer 2-B:

Remove Firebox top face support with a Phillips screwdriver. Take the eight screws out removing the firebox top face support. This will not be needed for the install.

Capa.2-B:

Quite la ayuda de cara superior de la caja de fuegos con un destornillador Phillips. Tome los ocho tornillos hacia fuera que quitan la caja de fuegos ayuda de cara superior. Esto no sera necesario para la instalaci6n. Vea el detalle de la foto.

PRE-CUT

Cambridge Pre-Packaged/ Pre-Cut MaytrX Fireplace Kit

2024

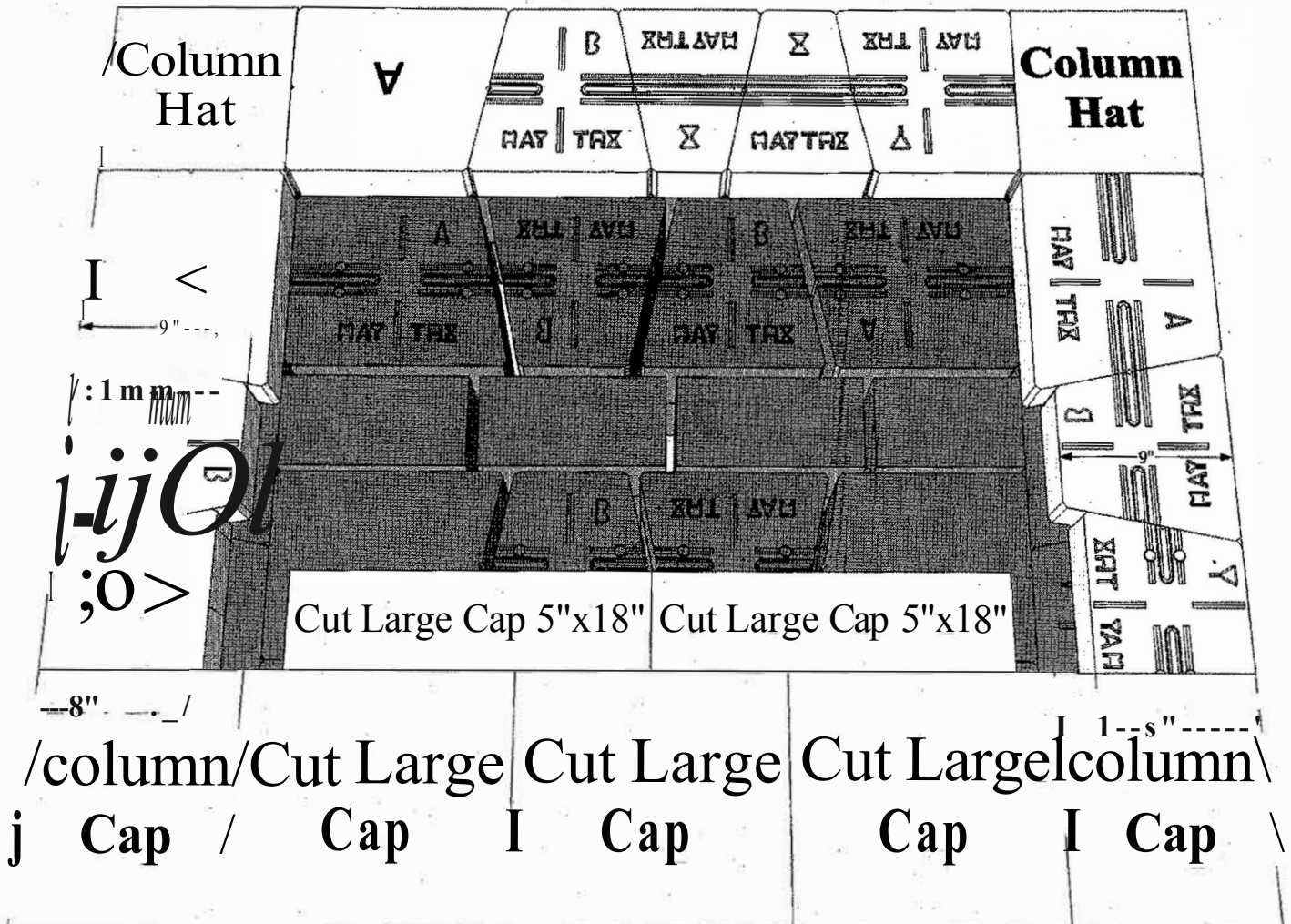

Layer 3:

Note: 3" Maytrx block and caps used on this course

Piece Count= (3) A, (1) B, (2) X, (1) Y, (2) Column hats, (2) 6"x8" Cut Y stones, (2) 9" Cut B stone, (2) 5"x18" Large cap cut stones, (2) Column cap stones, (3) 13.25"x12" Large cap cut stones

Apply concrete adhesive and install wall stones and cut stones according to the photo.

Capa 3:

*Por favoe Note que Maytrx 3" es usado en este curso

Numero de Piezas= (3) A (1) B (2)X (1) Y (2) Sombreros de columnas, (2) 6"x8" Cortads Y piedras, (2) 9" Cortadas B, (2) 5"x18" Piedras caps grandes cortadas,(2) Capas de columnas, (3) 13.25"x12" Capas grandes cortadas

Aplique el pegamento concreto e instalelo por la foto.

PRE-CUT

Cambridge Pre-Packaged/ Pre-Cut MaytRx Fireplace Kit

2024

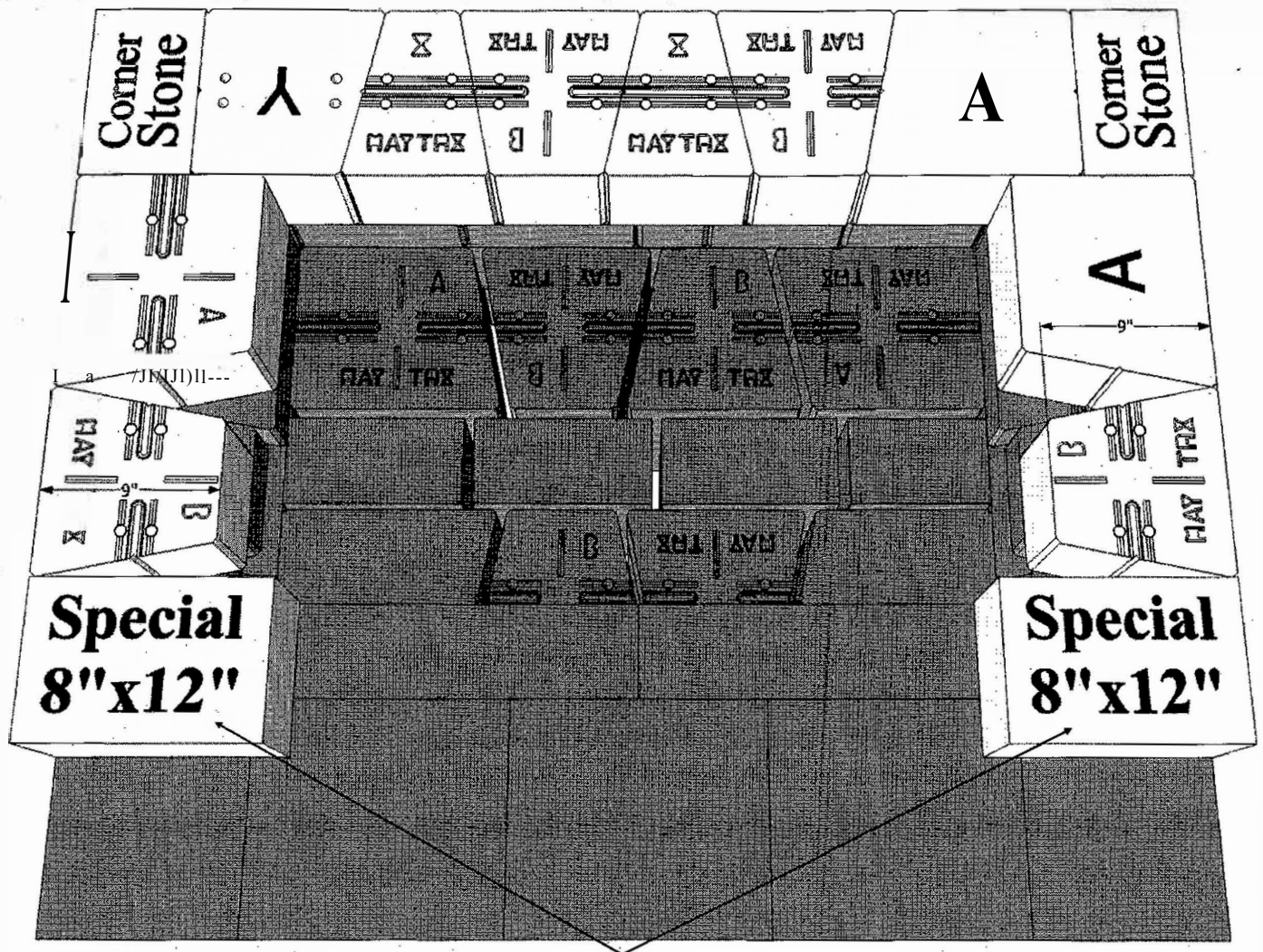

Start Layer 4 here: 9' in from the front face of Layer 3

Layer 4:

Piece Count= (3) A, (2) B (2) X, (1) Y, (2) 9' cut B stones, (2) 6"x10" Corner stones, (2) 8"x12" Special cut corners

Apply concrete adhesive and install wall stones and cut stones according to the photo.

Make sure the distance between the opening is 36"

Capa4:

Numero de Piezas = (3) A (4) B (2) X (1) Y (2) 6"x10" Esquinas (2) 8"x12" Esquinas cortadas especiales

Manteniendo todas las piedras llanas. Cercie rese de le para mantener los 36" abertura como se muestra.

Aplique el pegamento concreto e instalelo por la foto.

PRE-CUT

Cambridge Pre-Packaged/ Pre-Cut MayRx Fireplace Kit

2024

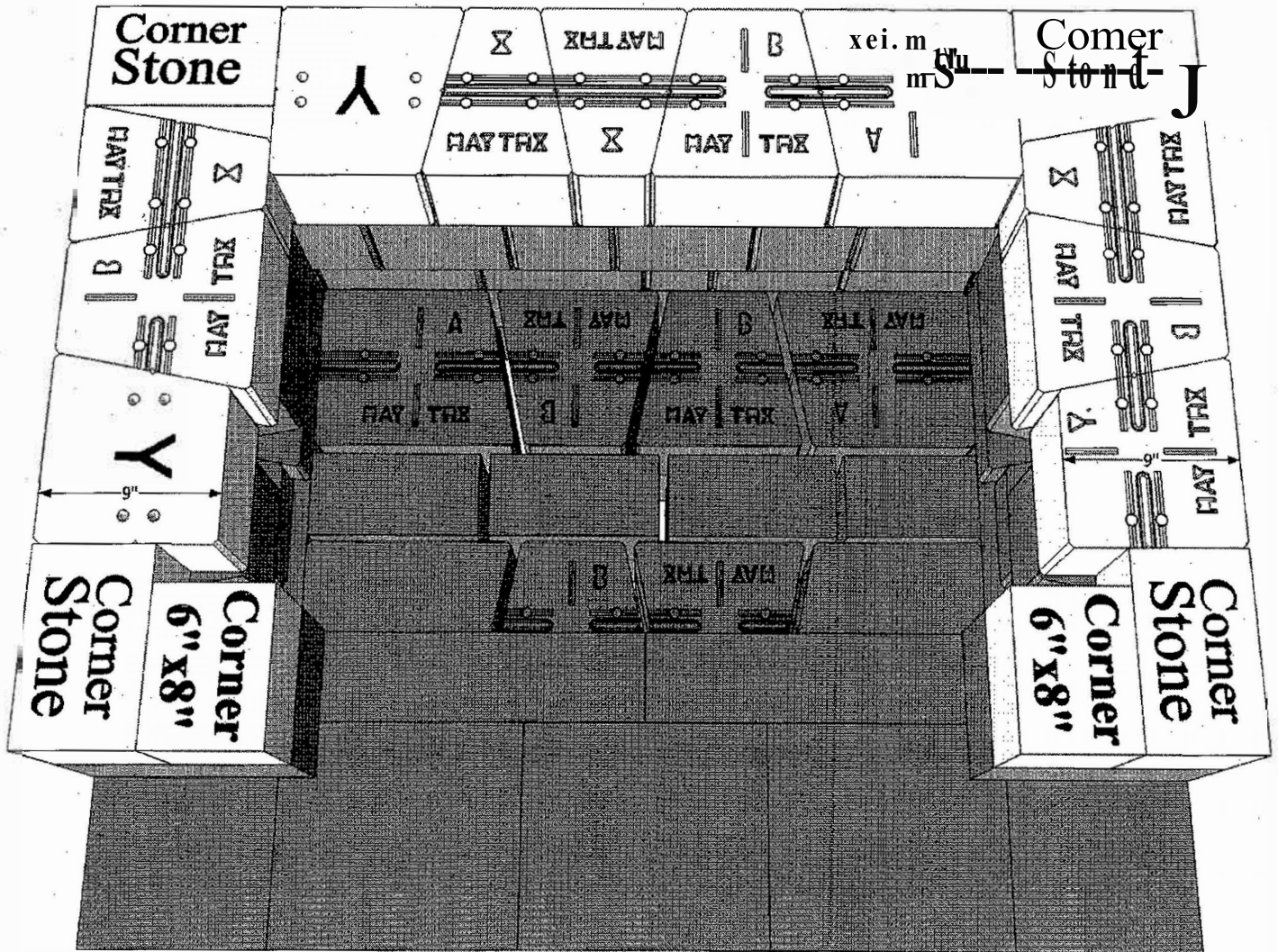

Layer 5:

Piece Count= (1) A, (3) B, (4) X, (2) Y, (2) 9" cut Y stones (4) 6"x 10" Comer stones, (2) 6"x8" Cut corner stones

Apply concrete adhesive and install wall stones and cut stones according to the photo.

Capa 5:

Numero de Piezas = (1) A (3) B (4) X (3) Y (4) 6"x 10" Esquinas, (2) 6"x 8" Esquinas cortadas

Aplique el pegamento concreto e instalelo por la foto.

PRE-CUT

Cambridge Pre-Packaged/ Pre-Cut MaytRx Fireplace Kit

2024

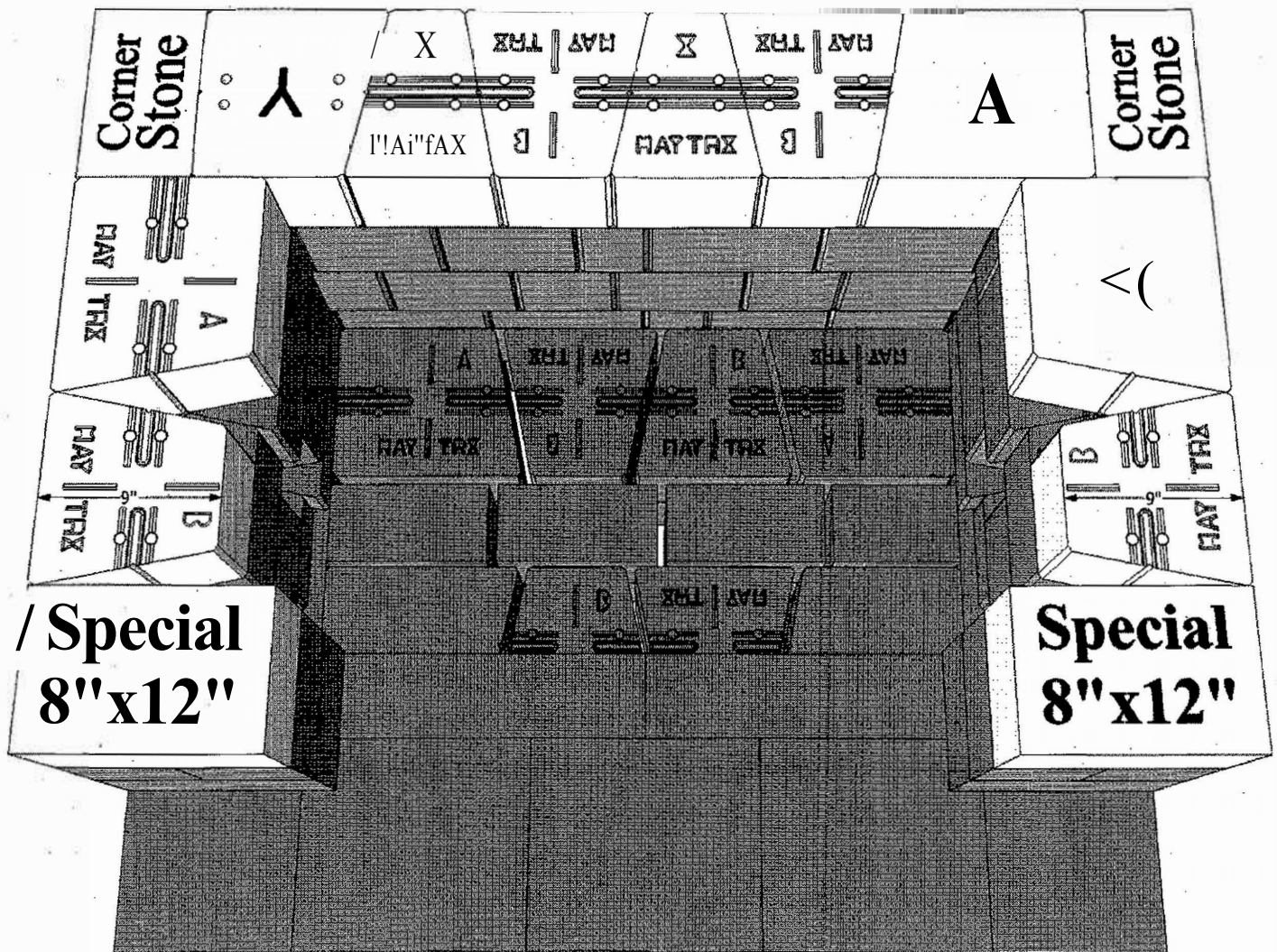

Layer 6:

Piece Count = (3) A, (2) B (2) X, (1) Y, (2) 9' cut B stones, (2) 6"x10" Corner stones, (2) 8"x12" Special cut corners

Apply concrete adhesive and install wall stones and cut stones according to the photo.

Make sure the distance between the opening is 36"

Capa 6:

Numero de Piezas = (3) A (4) B (2) X (1) Y (2) 6"x10" Esquinas, (2) 8"x12" Esquinas cortadas especiales

Manteniendo todas las piedras llanas. Cercie/rese de le para mantener los 36" abertura como se muestra.

Aplique el pegamento concreto e instalelo por la foto.

PRE-CUT

Cambridge Pre-Packaged/ Pre-Cut MaytRx Fireplace Kit

2024

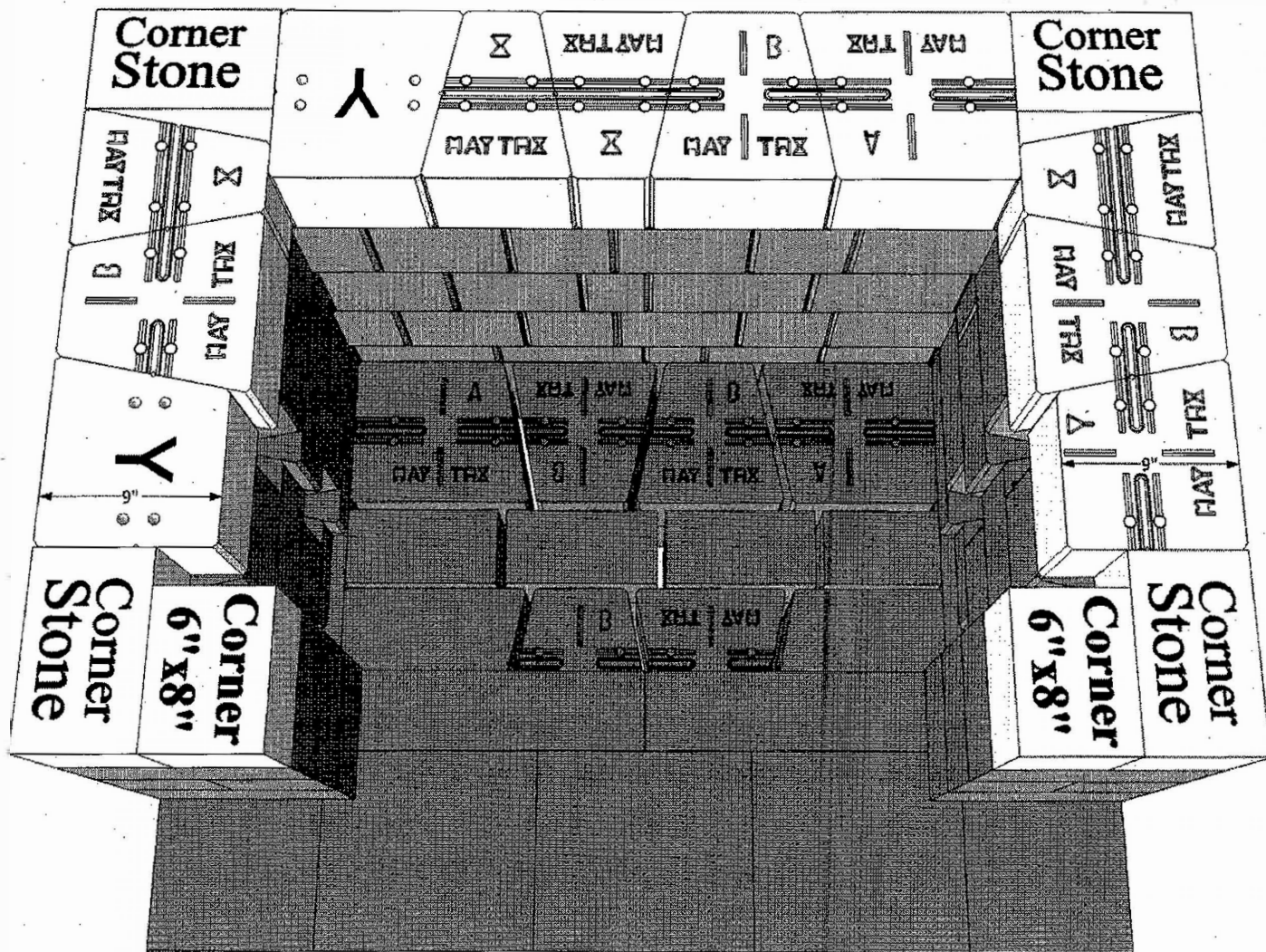

Layer 7:

Piece Count= (1) A, (3) B, (4) X, (1) Y, (2) 9' cut Y stones (4) 6"x 10" Corner stones, (2) 6"x8" Cut corner stones

Apply concrete adhesive and install wall stones and cut stones according to the photo.

Capa 7:

Numero de Piezas = (1) A (4) B (4) X (1) Y (4) 6"x10" Esquinas, (2) 6"x8" Esquinas cortadas

Aplique el pegamento concreto e instalelo por la foto.

PRE-CUT

Cambridge Pre-Packaged/ Pre-Cut MaytRx Fireplace Kit

2024

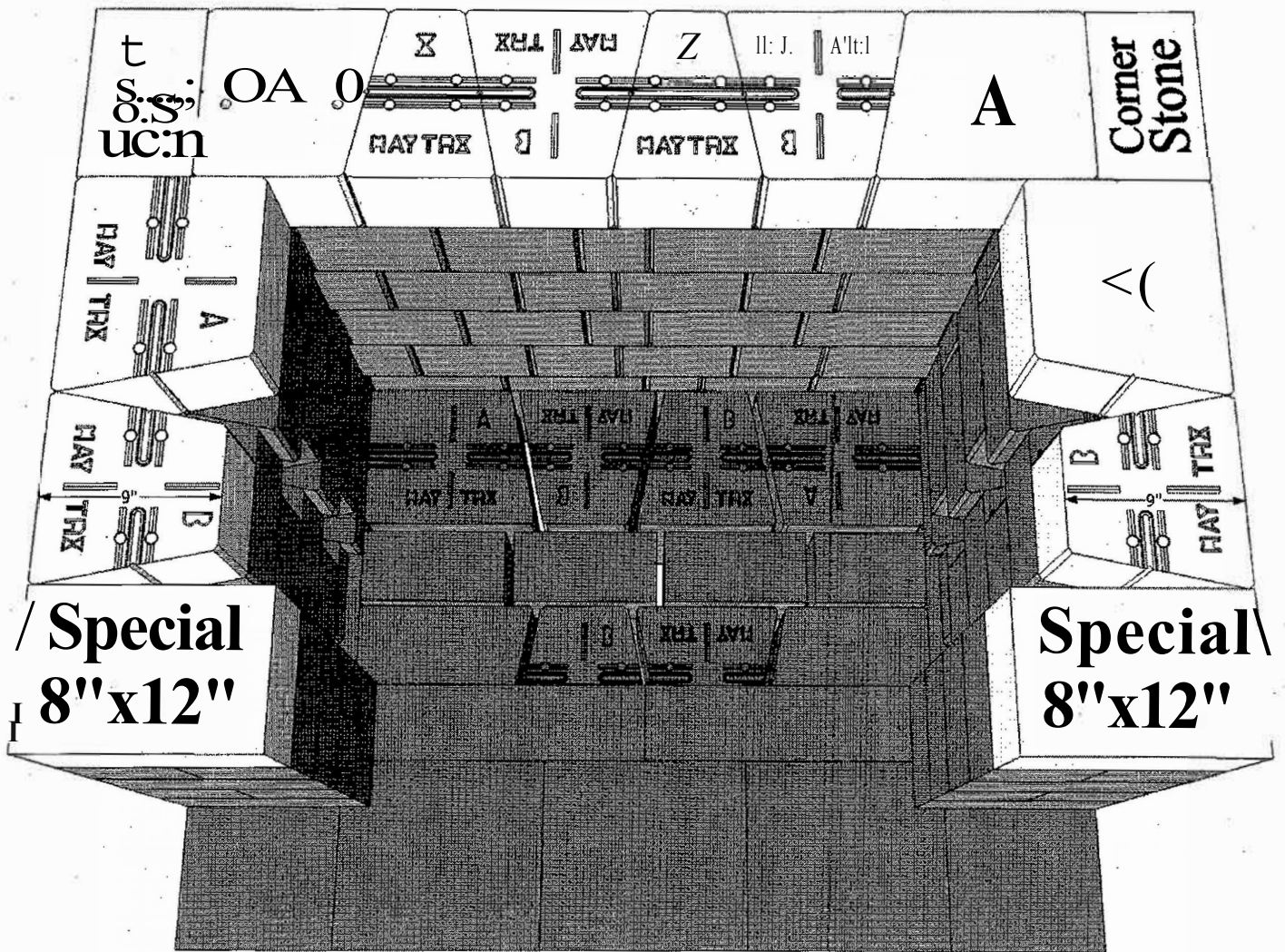

Layer 8:

Piece Count = (3) A, (2) B (2) X, (1) Y, (2) 9" cut B stones, (2) 6"x10" Corner stones, (2) 8"x12" Special cut corners

Apply concrete adhesive and install wall stones and cut stones according to the photo.

Make sure the distance between the opening is 36"

Capa 8:

Numero de Piezas = (3) A (4) B (2) X (1) Y (2) 6"x10" Esquinas, (2) 8"x12" Esquinas cortadas especiales

Manteniendo todas las piedras llanas. Cerciorese de le para mantener los 36" abertura como se muestra.

Aplique el pegamento concreto e instalelo por la foto.

PRE-CUT

Cambridge Pre-Packaged/ Pre-Cut MaytRx Fireplace Kit

2024

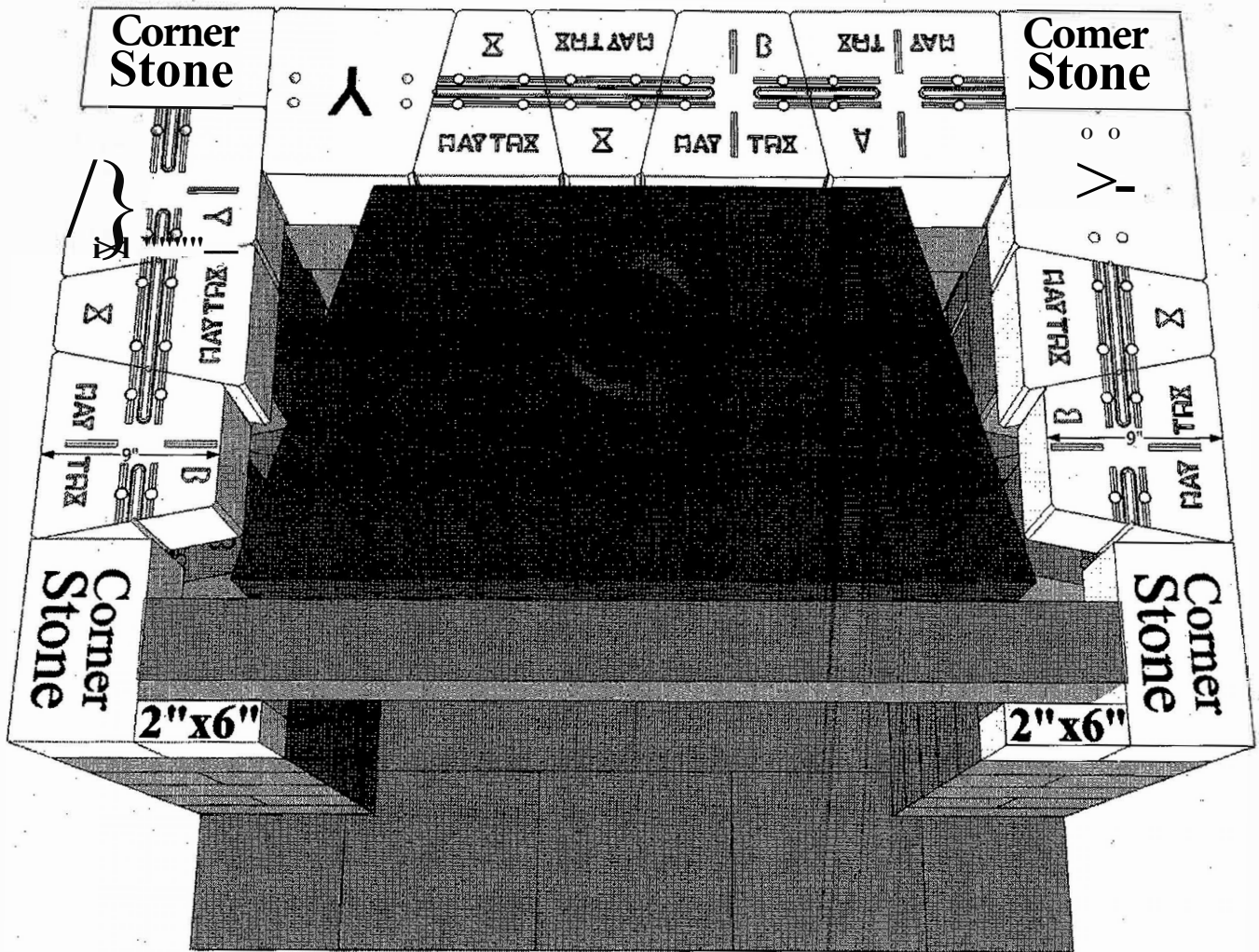

Layer 9:

Piece Count= (1) A, (1) B, (4) X, (3) Y, (4)
6"x10" Corner stones, (2) 9" cut Y Stones, (2)
2"x6" Cut stones

Apply concrete adhesive and install wall stones
and cut stones according to the photo.

Capa 9:

Numero de Piezas = (1) A (1) B (4) X (3) Y (4)
6"x10" Esquinas, (2) 5"x6" Piezas cortadas, (2)
10"x5" Piezas cortadas, (2) 2"x6" Piezas cortadas

Aplique el pegamento concreto e instalelo por la
foto.

PRE-CUT

Cambridge Pre-Packaged/ Pre-Cut MaytRx Fireplace Kit

2024

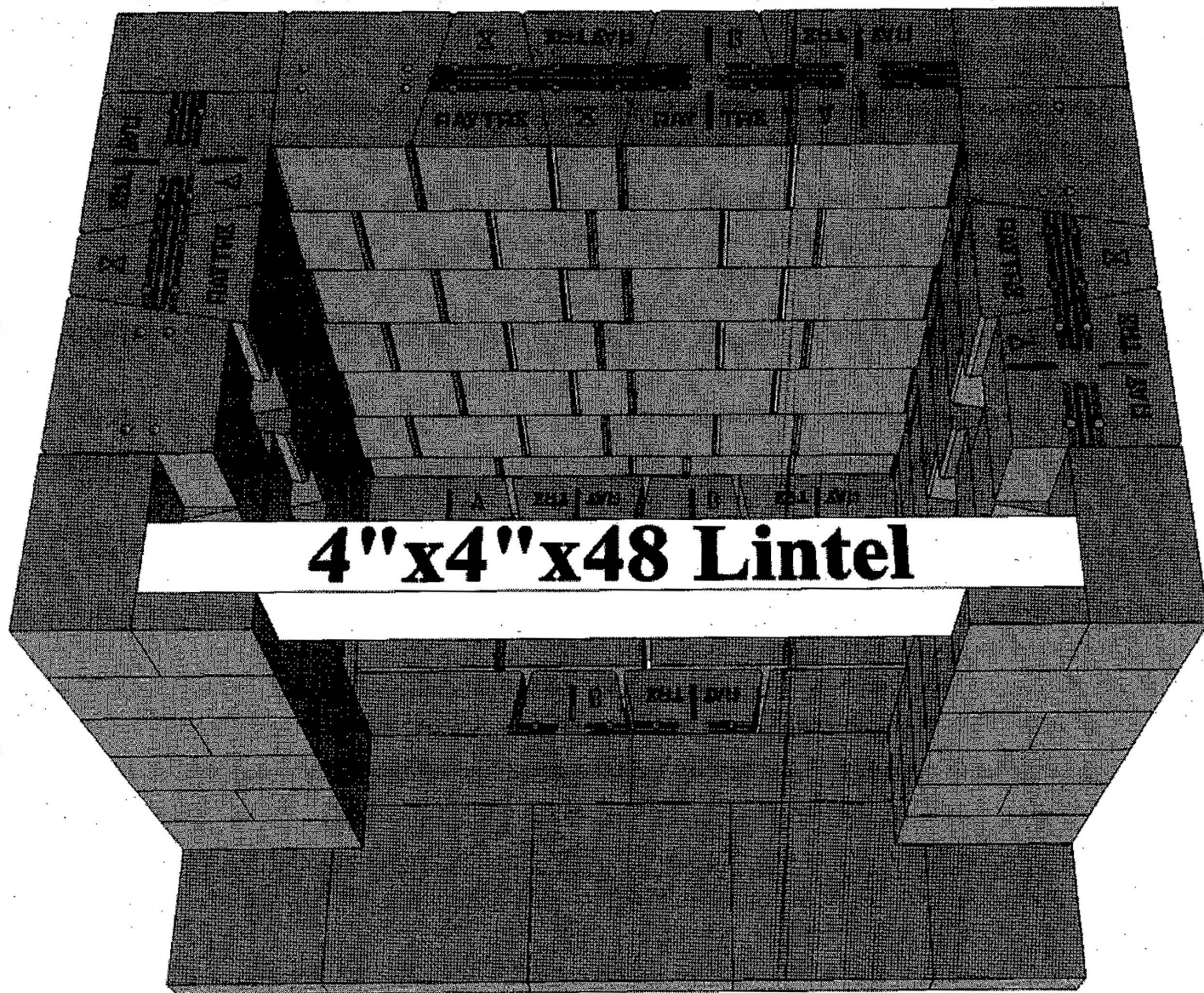

Layer 9-B: Lintel Placement

Piece Count= (2) 6" x4" 'x48 1/2" lintels

Apply concrete adhesive and install lintels according to the photo.

Capa 9-B: Colocaci3n del dintel;

Numero de Piezas = (2) 6" x4" x48 1/2" dintels

Aplique el pegamento concreto e instalelo por la foto.

PRE-CUT

Cambridge Pre-Packaged/ Pre-Cut MaytRx Fireplace Kit

2024

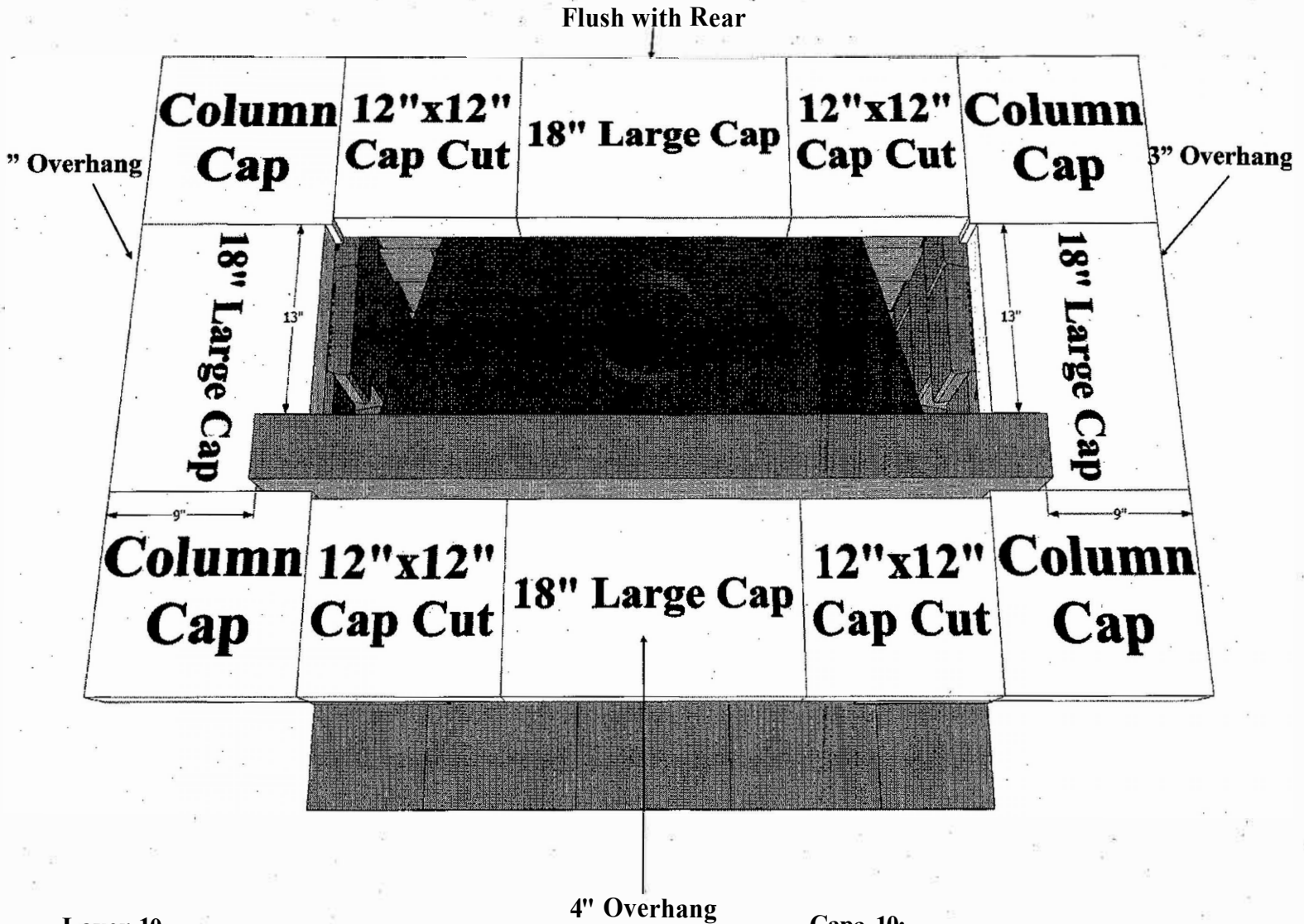

Layer 10:

Note: 3" Maytrix caps used on this course

Piece Count= (2) 18" Large caps, (4) Column caps, (4) 12"x12" Cut cap stones, (2) 9 x 18 cap cuts (2) 3 x 13 cap cuts

Install a 3" overhang on the left and right side, 4" overhang on the front and flush on back.

Apply concrete adhesive and install caps according to the photo.

Capa 10:

*Por Favor Note que Maytrix 3" casquillos es usados en este curso

Numero de Piezas = (4)18" Casquillos grandes, (4) Casquillos de columna, (4) 12"x12" Piedras cortadas de casquillo, (1) 4.5"x10" Casquillo cortado, (1) 4.5"x12" Casquillo cortado, (1) 4.5"x18" Casquillo cortado

Instate de modo que haya una proyeccion 3" proyeccion en el lado izquierdo y derecho, 4" en el frente, del resante parte posterior.

Aplique el pegamento concreto e instalelo por la foto.

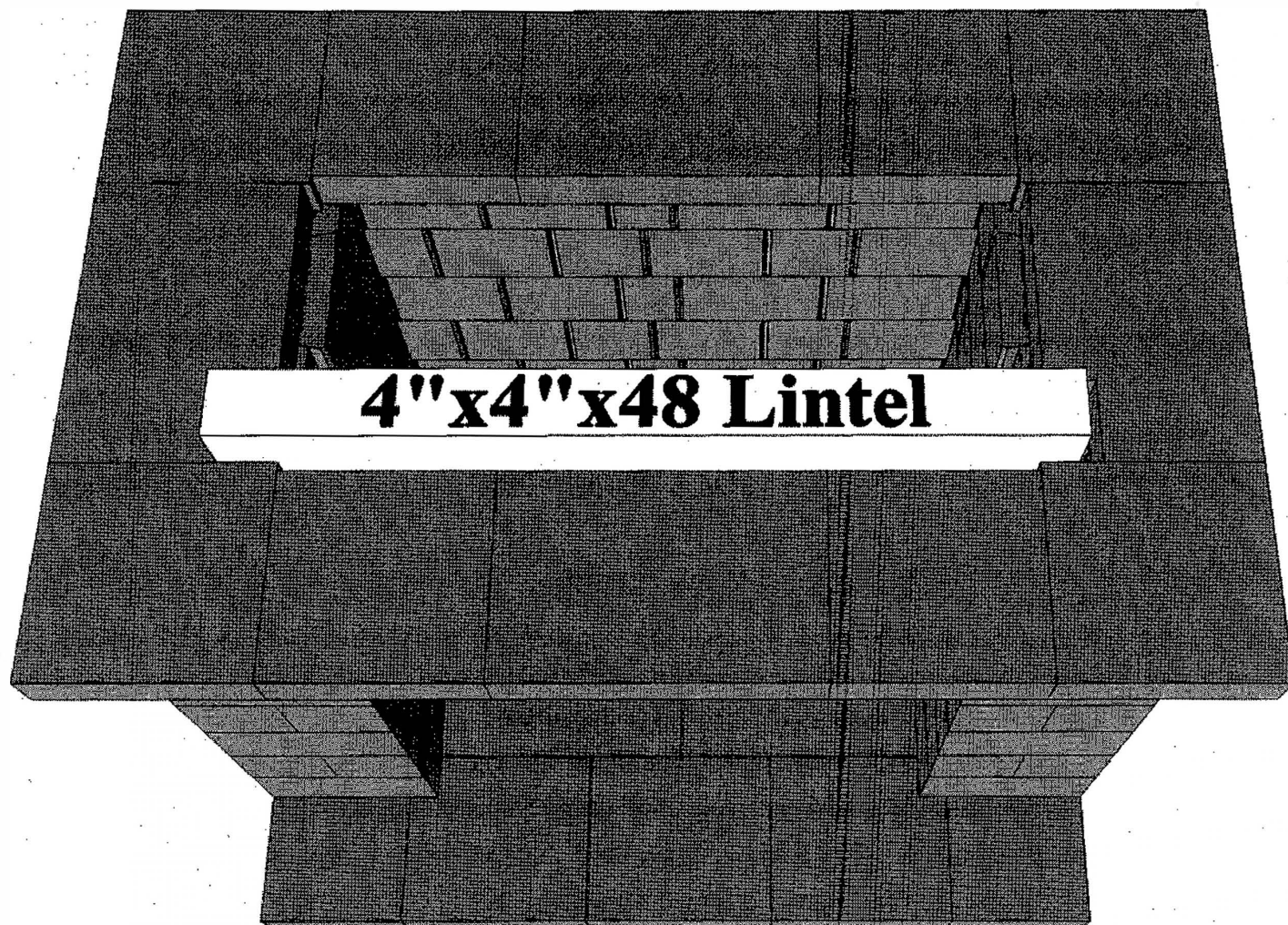

Layer 10-B: Lintel Placement

Piece Count= (1) 6' x4" x48 1/2" lintels

Apply concrete adhesive and install lintels according to the photo.

Capa 10-B:

Numero de Piezas = (1) 6' x4" x48 1/2" DeLintel

Aplique el pegamento concreto e instalelo por la foto.

PRE-CUT

Cambridge Pre-Packaged/ Pre-Cut MaytRx Fireplace Kit

2024

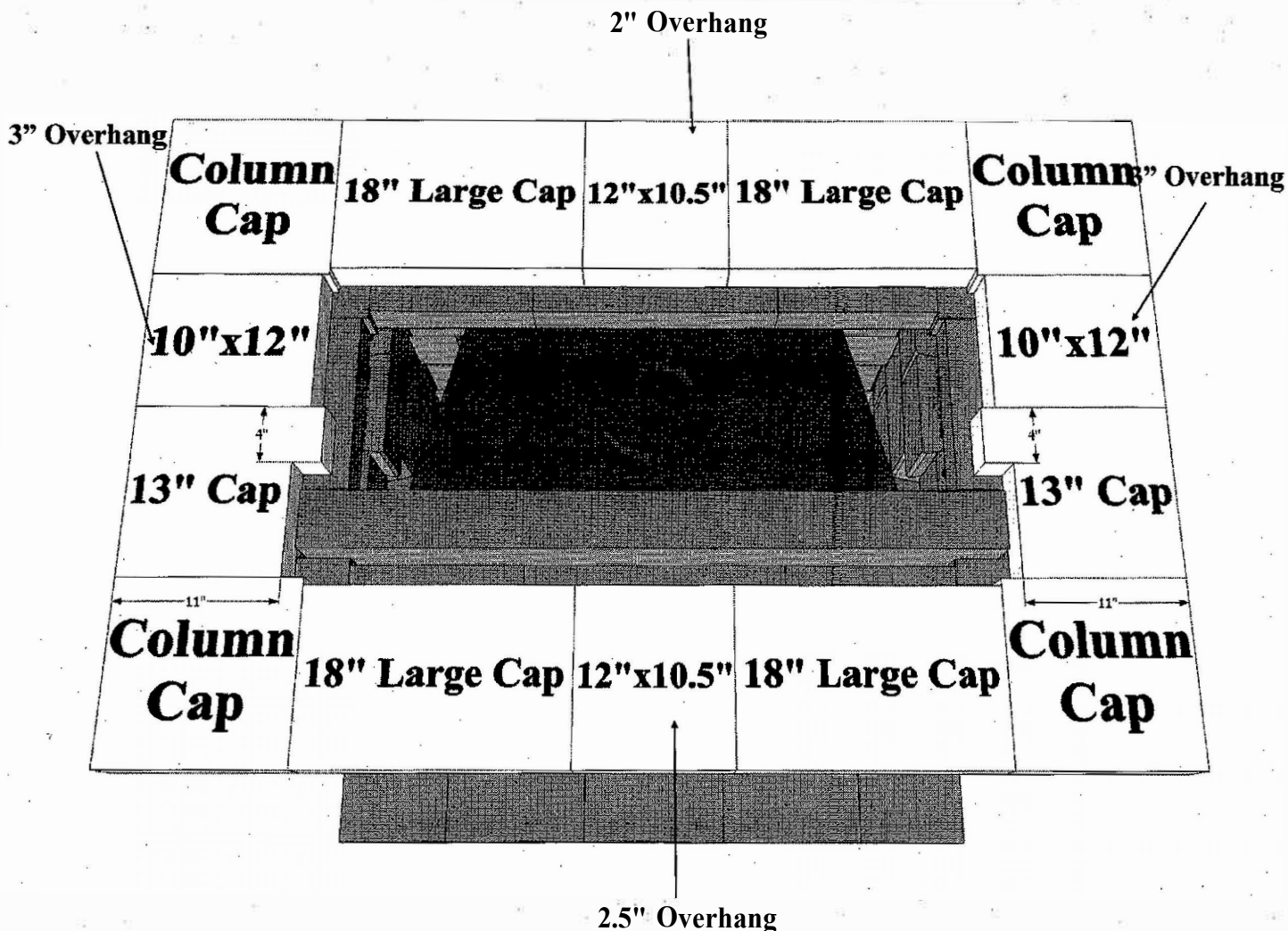

Layer 11:

Note: 3" Maytrx caps used on this course

Piece Count= (4) 18" Large caps, (4) Column caps, (2) 10.5"x12" Cut cap stones, (2) 10" x 12" Cut cap stones, (2) 11" x 12" cap cuts, (2) 2" x 4" cap cuts

Apply concrete adhesive and install caps according to the photo. Install a 3" overhang on the left and right sides. Install a 2.5" overhang on the front and 2" overhang on the back.

Capa 11:

*Por Favor Note que Maytrx 3" casquillos es usados en este curso

Numero de Piezas = (2) 13" Casquillos, (6) Casquillos grandes, (4) Casquillos de columna, (2) 10.5" x12" Capas cortadas de casquillo, (2) 10"x12" Piedras cortadas de casquillo, (2) 4 Piedras cortadas del casquillo 4.5" x12", (1) 7"x18" Piedra cortada del casquillo.

Instate la proyeccion 3" en los lados izquierdas y derechas . Instate la proyeccion 2.5" proyeccion en el frente y 2" encendido detras.

Aplique el pegamento concreto e instalelo por la foto.

PRE-CUT

Cambridge Pre-Packaged/ Pre-Cut MaytRx Fireplace Kit

2024

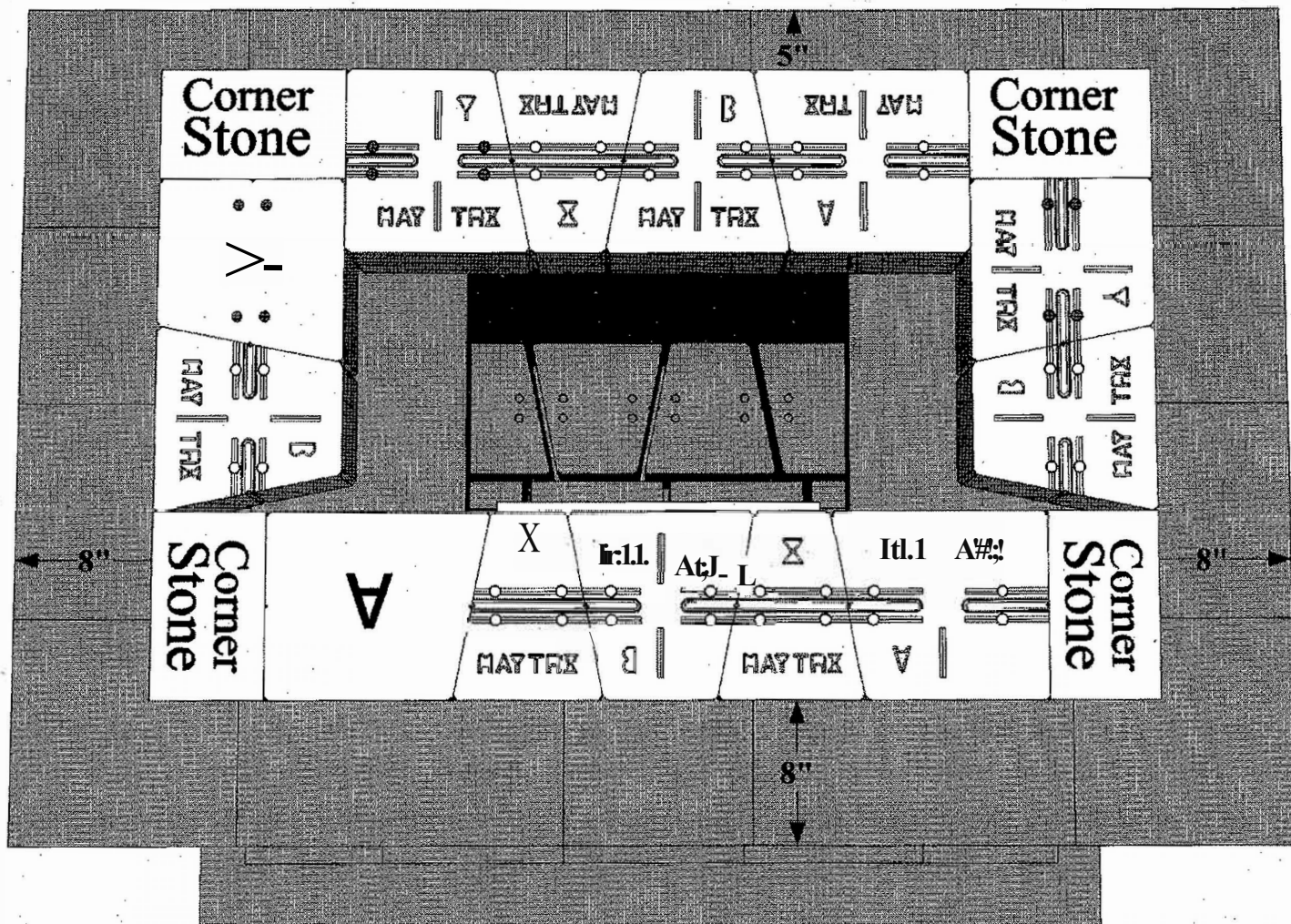

Layer 12:

Piece Count = (3) A (4) B (3) X (3) Y (4) 6"x 10"
Corner stones

Apply concrete adhesive and install wall stones
according to the photo.

Install an 8" step-in on the left, right and front
sides, and a 5" step-in on back.

Capa 12:

Numero de Piezas = (3) A (4) B (3) X (3) Y (4) 6"x
10" Esquinas

Instale 8" paso en partes izquierdas, derechas y,
alante con 5" paso encendido la parte posterior.

Aplique el pegamento concreto e instalelo por la
foto.

PRE-CUT

Cambridge Pre-Packaged/ Pre-Cut MaytRx Fireplace Kit

2024

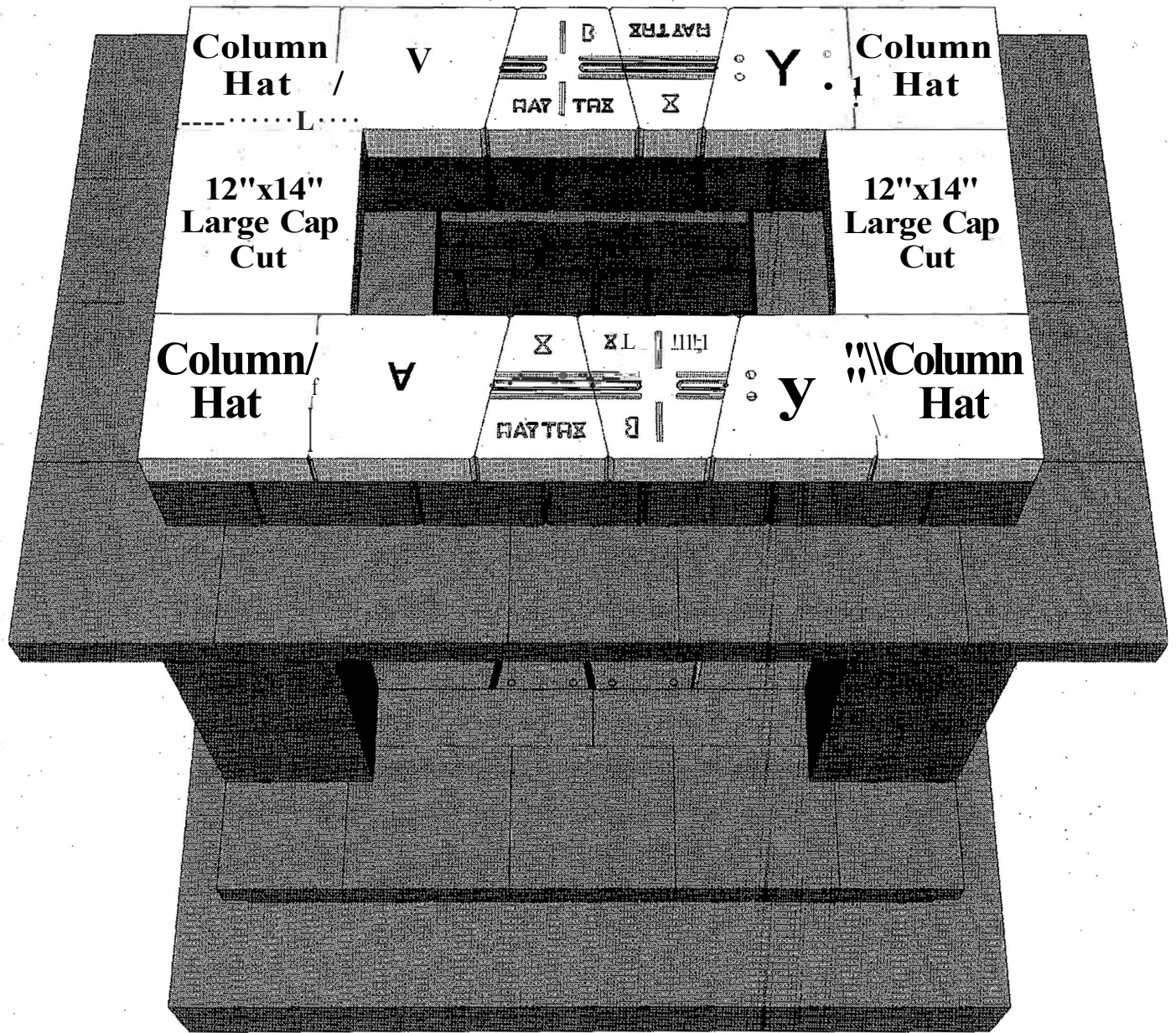

Layer 13:

*Please note 3" Maytrx block used on this course

Piece Count= (2) A, (2) B, (2) X, (2) Y, (2)
12"x14" Large cap cut stones, (4) Column hats

Apply concrete adhesive and install wall stones
according to the photo.

Capa 13:

*Por Favor Nota que bloque de Maytrx 3" es usa-
do en este curso

Numero de Pie as = (2) A (2) B (2) X (2) Y (2)
14" x12" Casquillo grandes, (4) Sombreros de
columna

Aplique el pegamento concreto e instalelo por la
foto.

PRE-CUT

Cambridge Pre-Packaged/ Pre-Cut MaytRx Fireplace Kit

2024

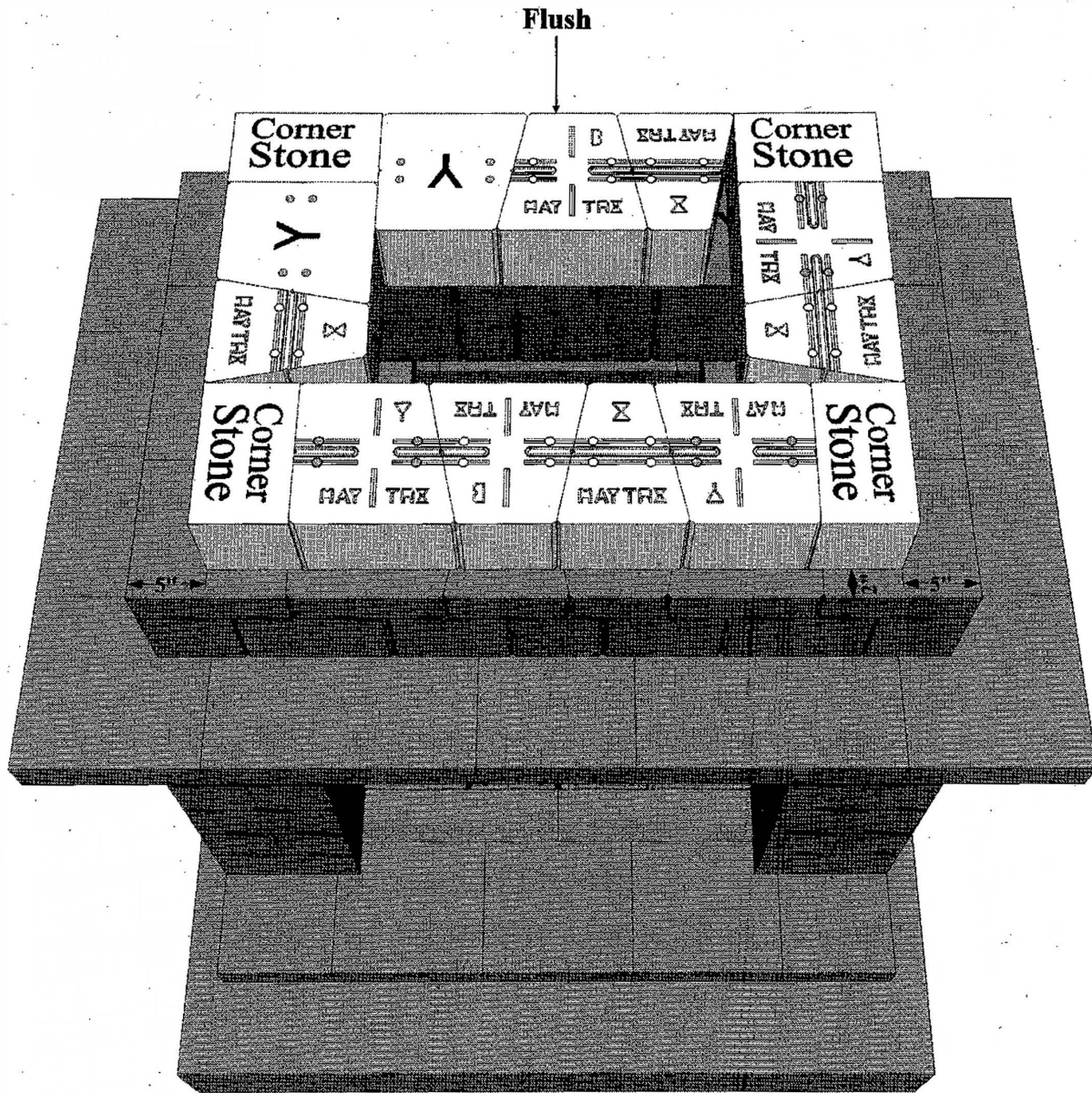

Layer 14:

Piece Count= (2) B, (4) X, (5) Y, (4)
6"x10" Corner stones

Apply concrete adhesive and install wall stones
according to the photo.

Install a 5" step-in on the left and right side, 2"
step-in on the front and flush on the back.

Capa 14:

Numero de Piezas = (2) B (4) X (5) Y (4)
10"Esquinas

Instale 5" paso en los lados izquierdos y derechos.
echan a un lado, 2" paso en frente y restantes
alante y detras.

Aplique el pegamento concreto e instalelo por la
foto.

**PRE-CUT Cambridge Pre-Packaged/ Pre-Cut MaytRx
Fireplace Kit**

2024

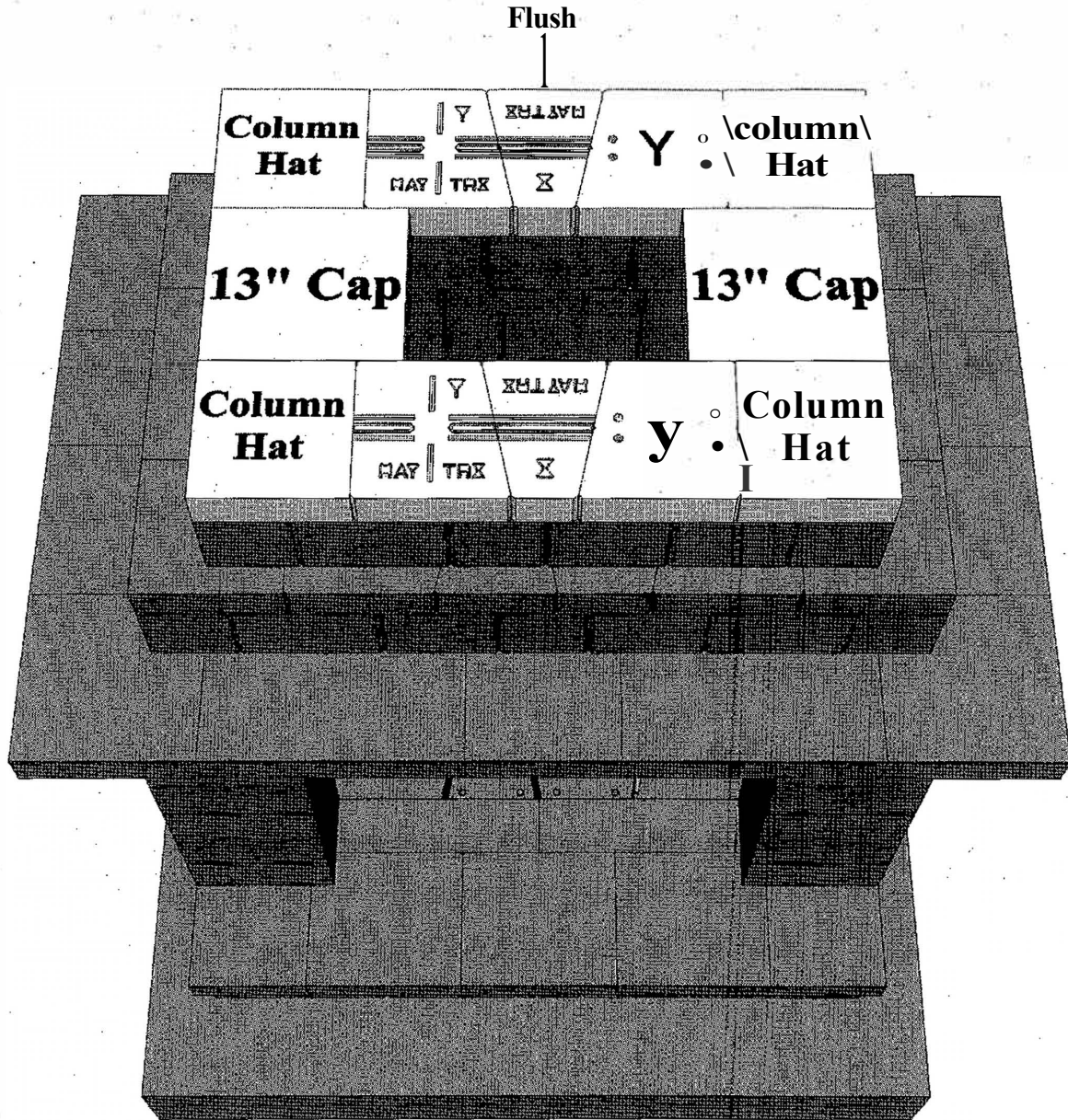

Layer 15:

Note: 3" Maytrx block used on this course

Piece Count= (2) X, (4) Y, (2) 13" caps, (4) Column hats

Apply concrete adhesive and install wall stones according to the photo.

Capa 15:

*Por Favor Nota casquillo de Maytrx 3" usado en este curso

Numero de Piezas = (2) X (4) Y (2) 13" capas, (4) Sombreros de la columna

Aplique el pegamento concreto e instale por la foto.

PRE-CUT Cambridge Pre-Packaged/ Pre-Cut MaytRx
Fireplace Kit

2024

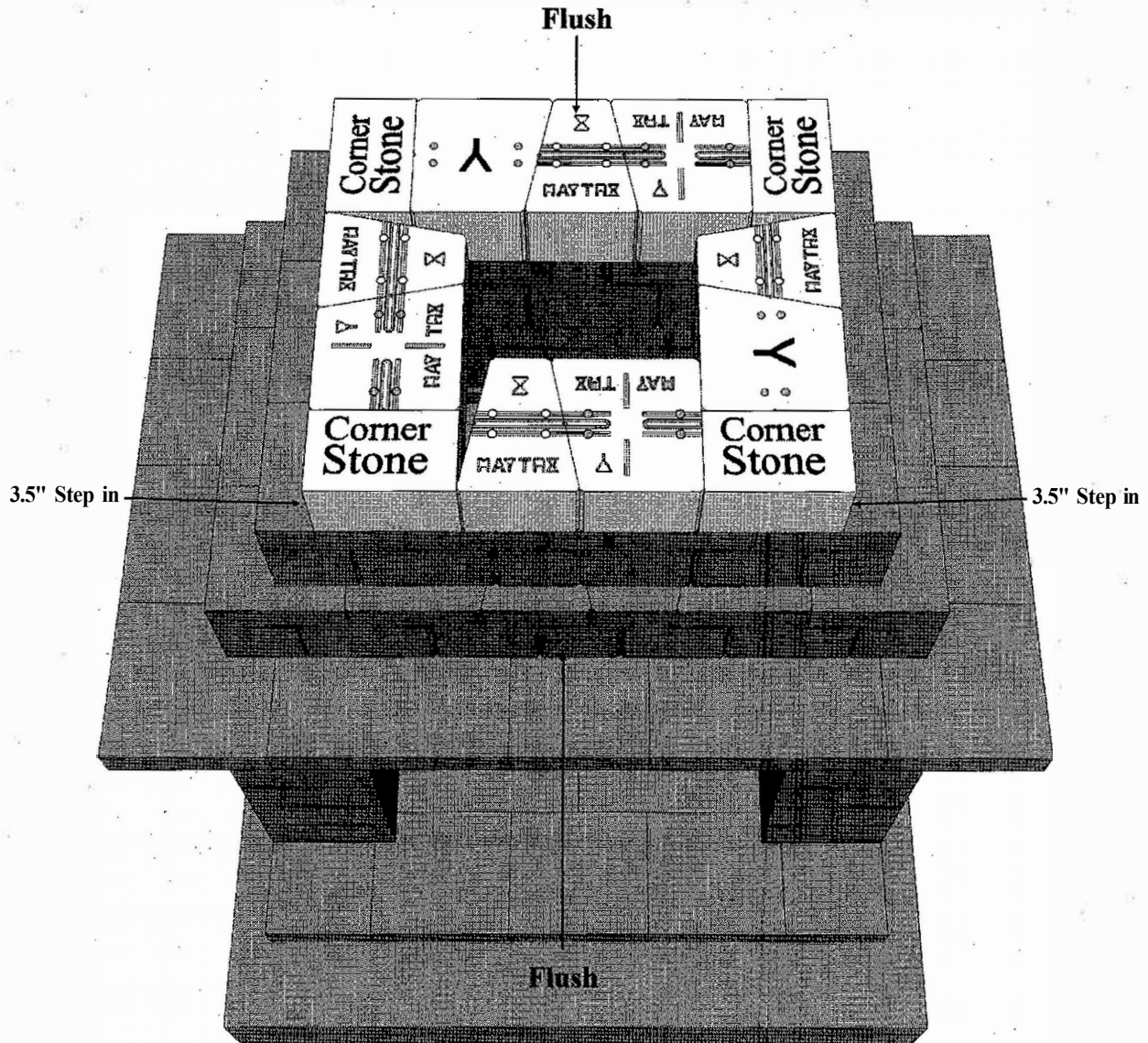

Layer 16:

Piece Count= (4) X (5) Y (4) 6"x 10" Corner stones

Install a 3.5" step-in on the left and right sides. Front and back edges are flush.

Apply concrete adhesive and install wall stones according to the photo.

Capa 16:

Numero de Piezas = (4) X (5) Y (4) 6"x 10" Esquinas

Instale un 3.5" paso en lados izquierdos y derechos. Los bordes delanteros y traseros son rasantes. Aplique el pegamento concreto e instalelo por la foto.

PRE-CUT Cambridge Pre-Packaged/ Pre-Cut MaytRx
Fireplace Kit

2024

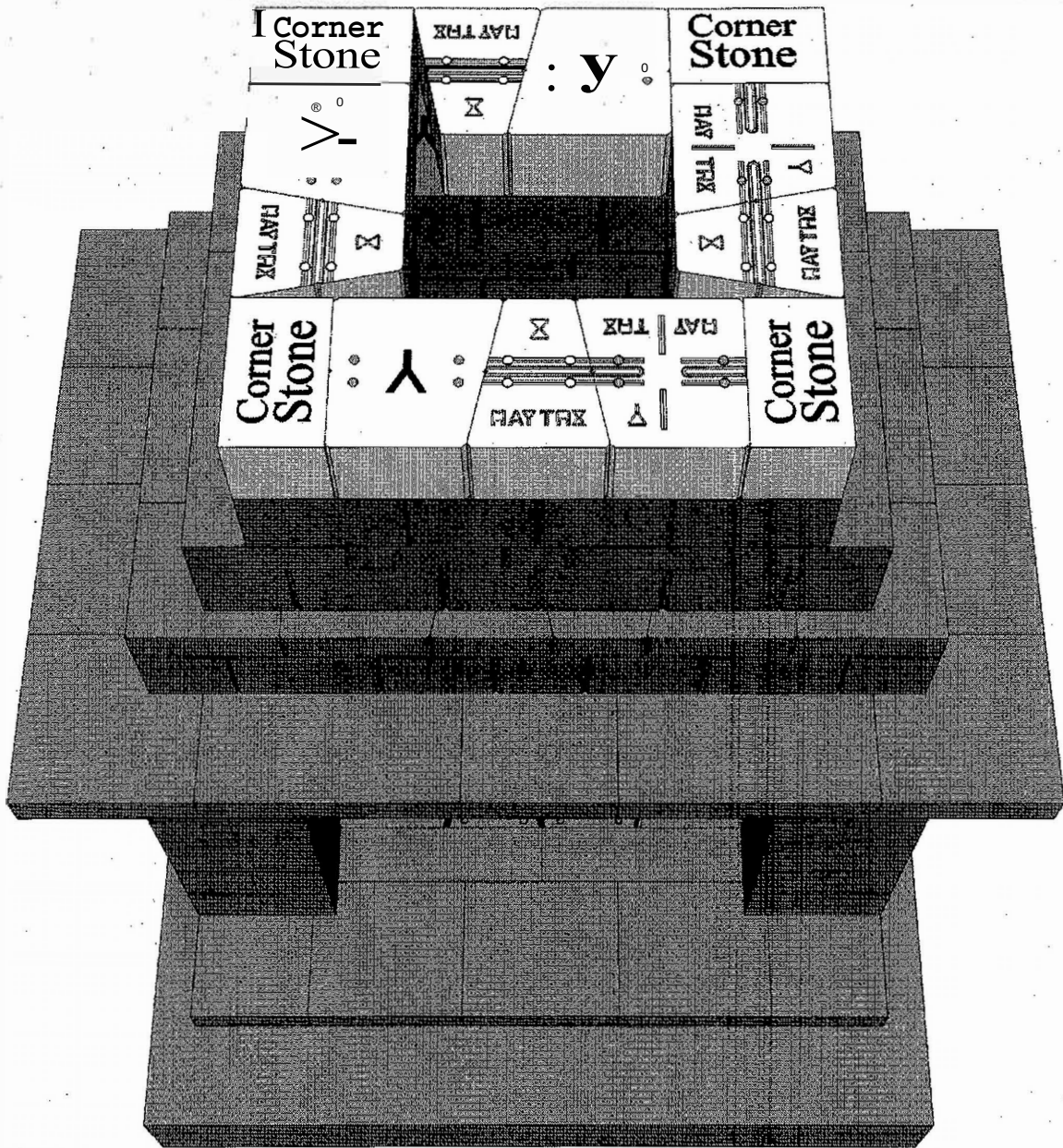

Layer 17:

Piece Count= (4) X (5) Y (4) 6"x10" Corner stones

Apply concrete adhesive and install wall stones according to the photo,

Capa 17:

Numero de Piezas = (4) X (5) Y (4) 6" x 10" Esquinas

Aplique el pegamento concreto e instalelo por la foto.

PRE-CUT

Cambridge Pre-Packaged/ Pre-Cut MaytRx Fireplace Kit

2024

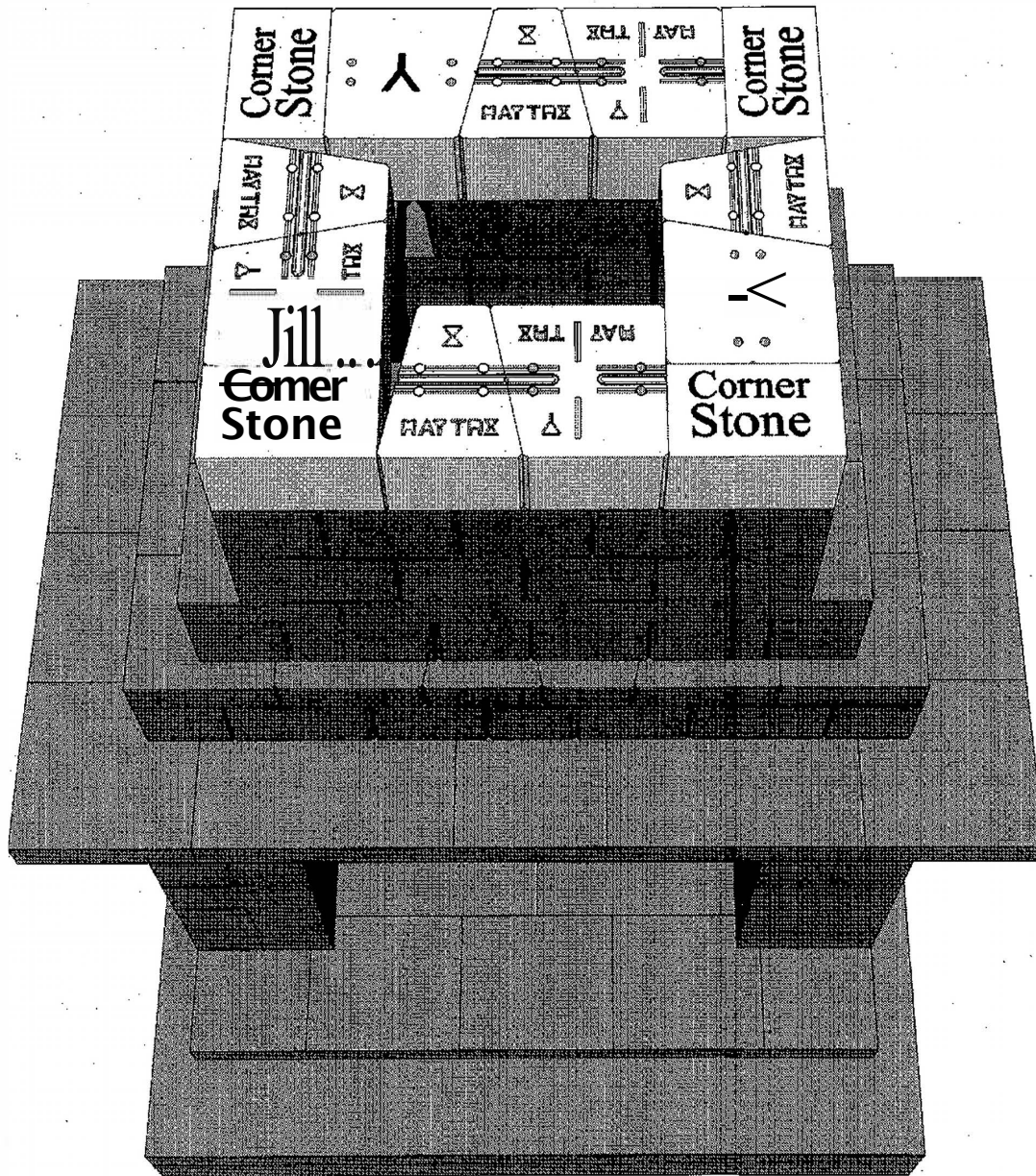

Layer 18:

Piece Count = (4) X (5) Y (4) 6"x10" Corner stones

Apply concrete adhesive and install wall stones according to the photo.

Capa 18:

Numero de Piezas = (4) X (5) Y (4) 6"x 10" Esquinas

Aplique el pegamento concreto e instalelo por la foto.

PRE-CUT Cambridge Pre-Packaged/ Pre-Cut MaytRx
Fireplace Kit

2024

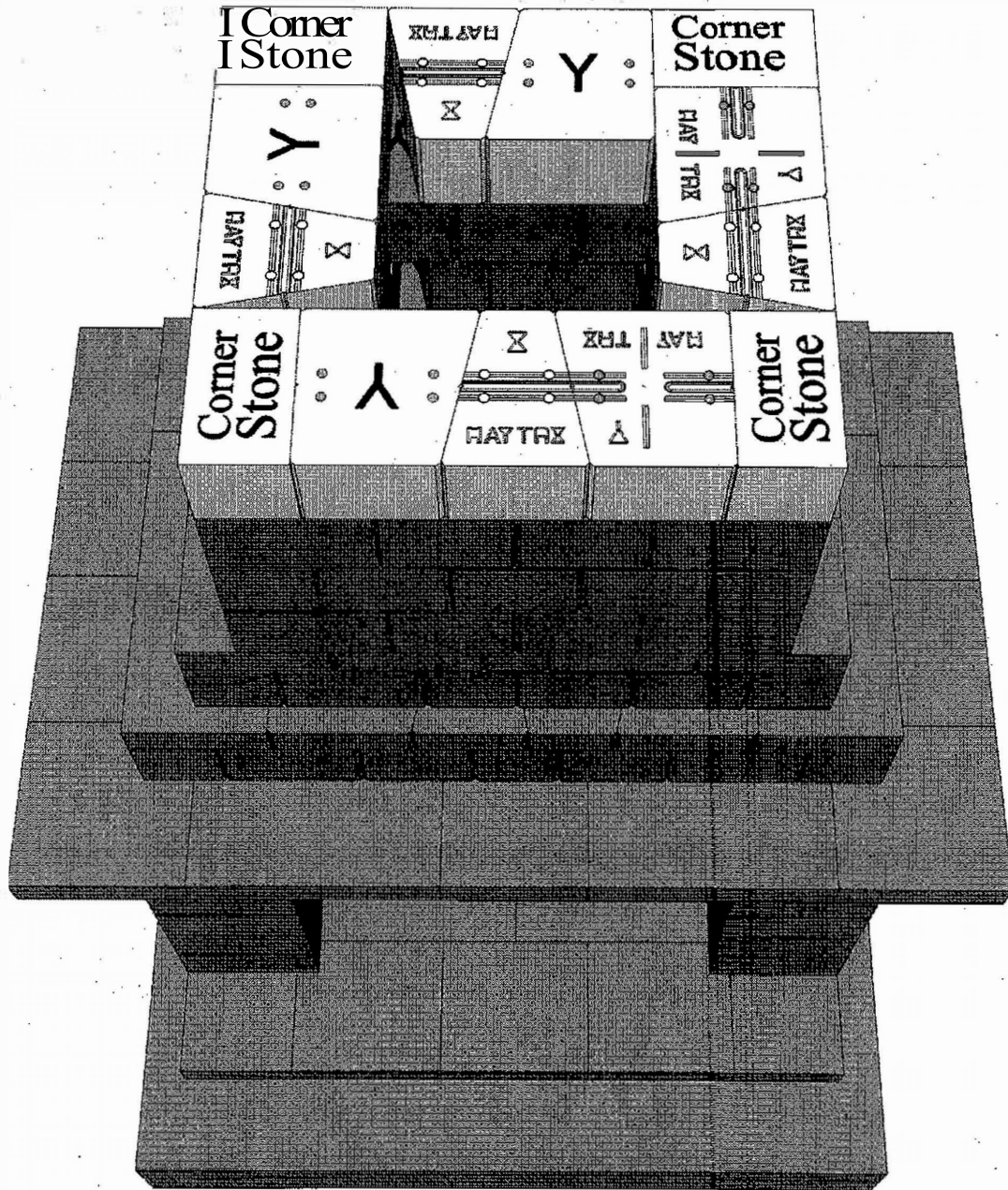

Layer 19:

Piece Count= (4) X (5) Y (4) 6"x10" Corner stones

Apply concrete adhesive and install wall stones according to the photo.

Capa 19:

Numero de Piezas = (4) X (5) Y (4) 6"x 10" Esquinas

Aplique el pegamento concreto e instalelo por la foto.

PRE-CUT Cambridge Pre-Packaged/ Pre-Cut MaytRx
Fireplace Kit

2024

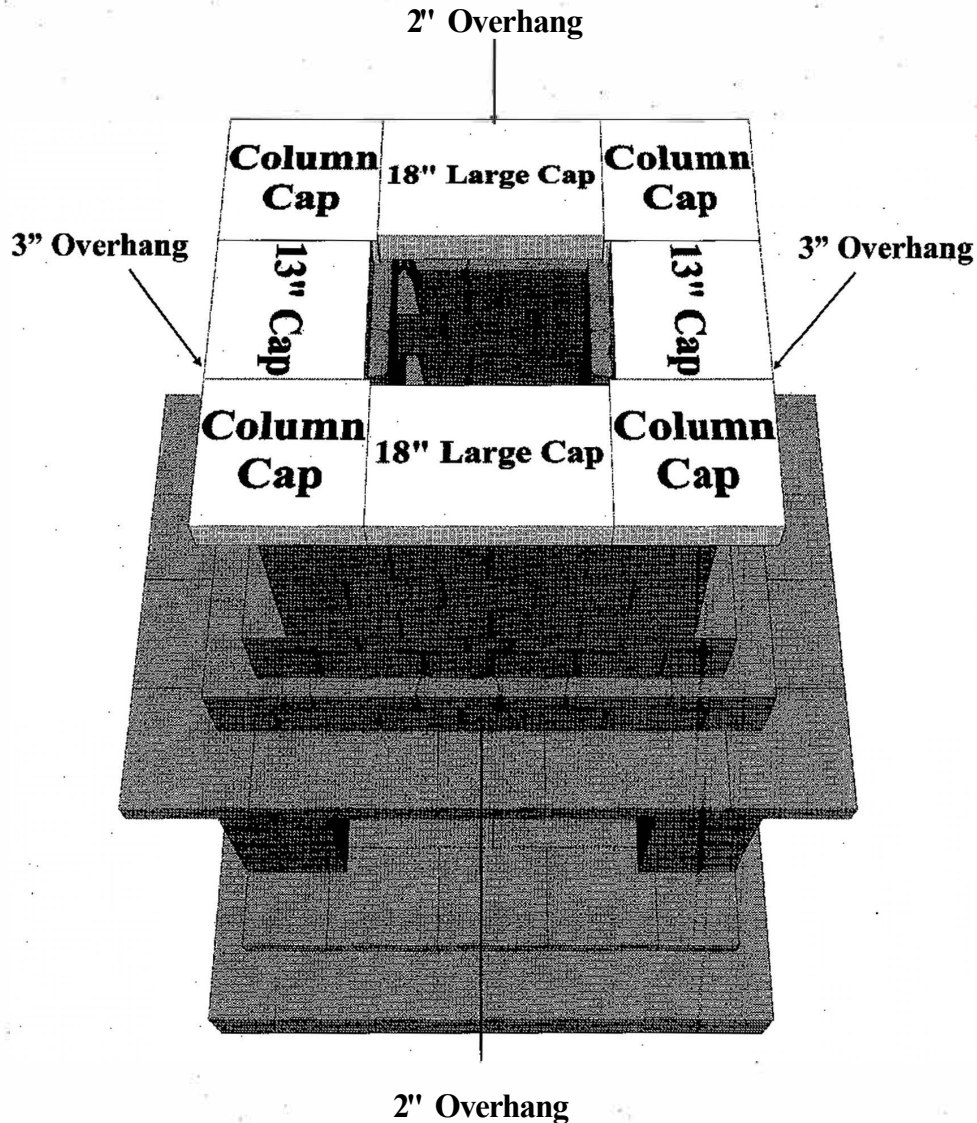

Layer 20:

Note: 3" Maytrx cap used on this course

Piece Count= (2) 13" Caps, (2) 18" Large caps,
(4) Column caps

Install a 3" overhang on the left and right sides
and a 2" overhang on the front and back.

Apply concrete adhesive and install caps accord-
ing to the photo.

Capa 20:

*Por Favor Nota casquillo de Maytrx 3" usado en
este curso

Numero de Piezas = (2) 13" Casquillos, (2) 18"
Casquillos grandes, (4) Casquillos de columna

Instale una proyeccion 3" proyeccion en lado
izquierdo y derecho con 2" en frente y detras.

Aplice el pegamento concreto e instalelo por la
foto.

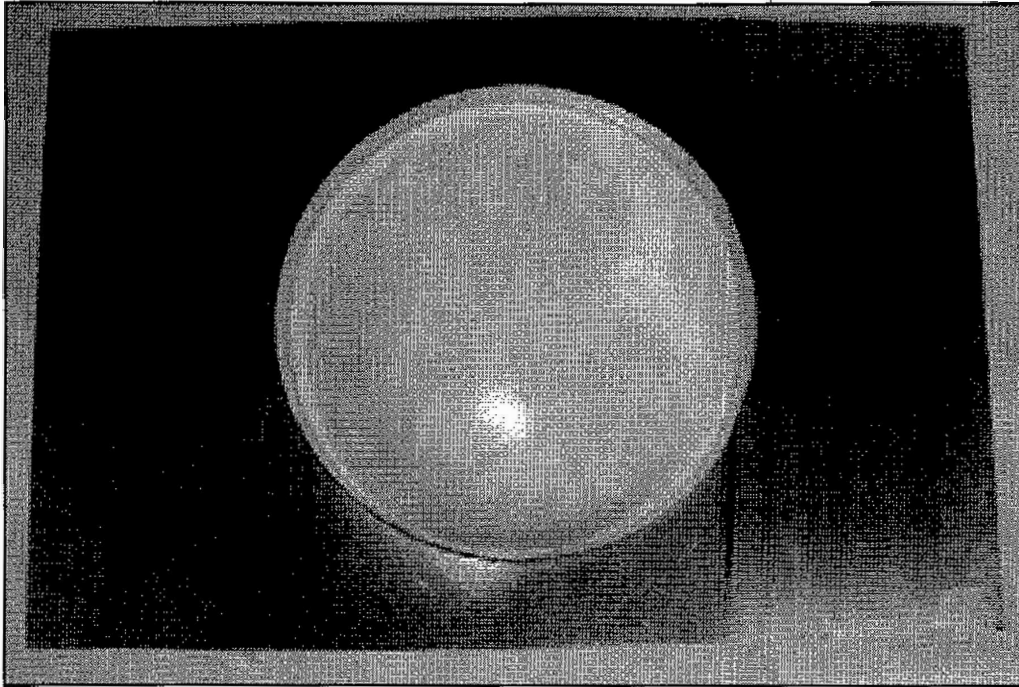

Chase flashing • El destellar de la persecucion

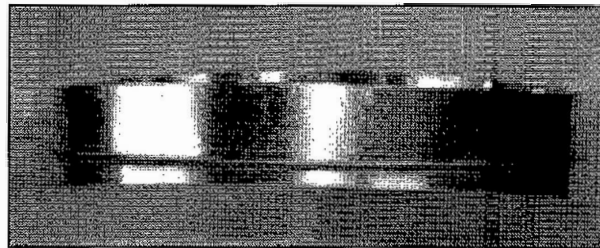

**Chase flashing with collar facing up.
Persecucion que destella con el revestimiento del collar para arriba.**

PRE-CUT Cambridge Pre-Packaged/ Pre-Cut MaytRx
Fireplace Kit

2024

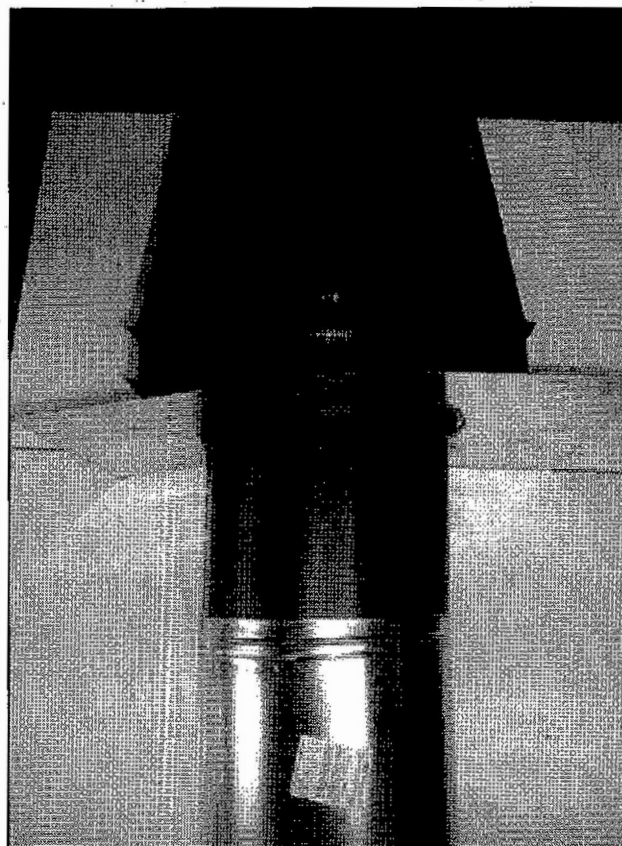
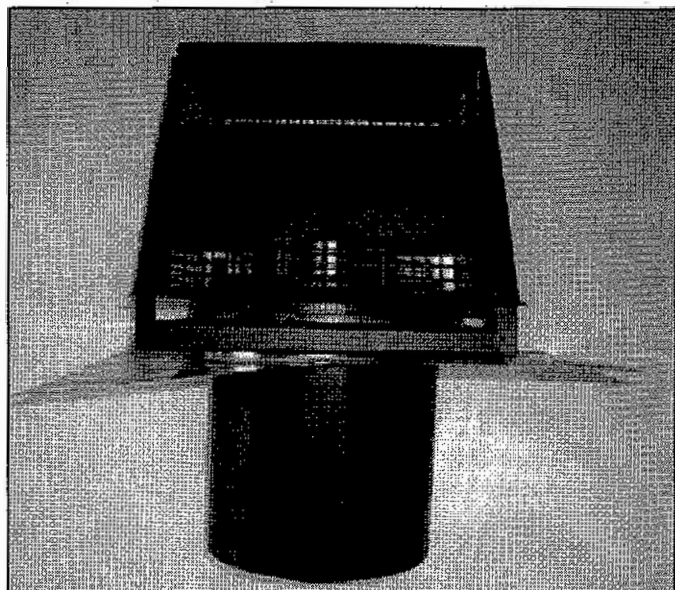

Once the chimney has been centered, take the chase flashing with the collar up and slide it on to the termination cap sleeve until it is flush with the bottom of the termination cap. (See photo top left)

(See photo top right) on how the termination cap, chase flashing and chimney section should line up inside the block chimney cavity. Take the entire assembly to the top of the fireplace chimney and carefully slide the termination cap sleeve into the chimney section while rotating left to right so the sections line up and sleeve together.

Una vez que la chimenea se ha centrado, tome la persecuci n intermitente con el cuello hacia arriba y deslicelo a la manga de la tapa de terminaci n hasta que quede al ras con la parte inferior de la tapa de terminaci n. (Ver foto) Imagen detallada de c mo la tapa de terminaci n, la persecuci n de parpadear y secci n de la chime-nea deben alinearse dentro de la cavidad chimenea bloque. (Ver foto) Tome todo el conjunto de la parte superior de la chimenea chimenea, deslice con cuidado la tapa de terminaci n de la manga en la secci n de la chime-nea mientras gira de izquierda a derecha por lo que la linea de secciones y manga juntos.

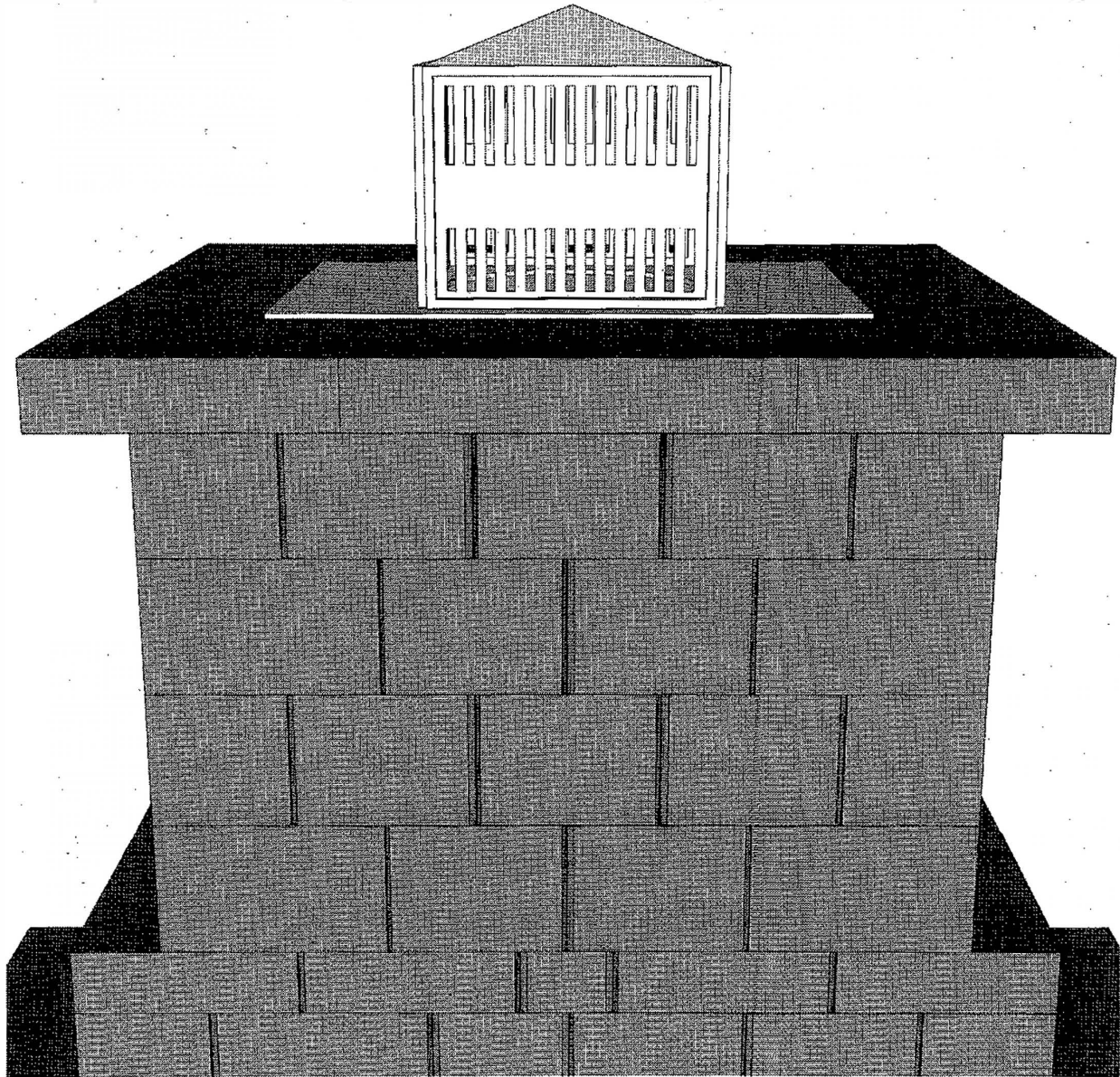

Once you have the termination cap sleeved into the chimney section, you can apply silicone between the final layer of block and the chase flashing to prevent any water or foreign material from entering the chimney cavity. Locate the pre-drilled holes in termination cap. Then drill into both sides of chase flashing. Install sheet metal screws and screw in cap. Do the same on opposite side.

Una vez que usted tiene la tapa de terminación de manga en la sección de la chimenea, puede aplicar silicona entre la capa final de bloque y la persiana intermitente para evitar que el agua o material extraño en la cavidad chimenea. Busque la pre-agujeros en la tapa de terminación. A continuación, perfora en ambos lados de la persiana a parpadear. Instale los tornillos de chapa metálica y el tornillo de la tapa. Haga lo mismo en el lado opuesto.

PRE-CUT Cambridge Pre-Packaged/ Pre-Cut MaytRx Fireplace Kit

2024

Facing Lintel With Granite Tile:

In your fireplace kit you will find 5 pieces of 6"x6" granite tile. The granite is to be applied to the face of the concrete lintel (polished side facing out) at the top of the fire box using concrete adhesive. Make sure you use a retaining wall adhesive that will not be affected by the heat from the fire box.

Note: There are 6 pieces of 6"x6" granite tile in your kit as well, these are for the addition of wood boxes should they be a part of your installation.

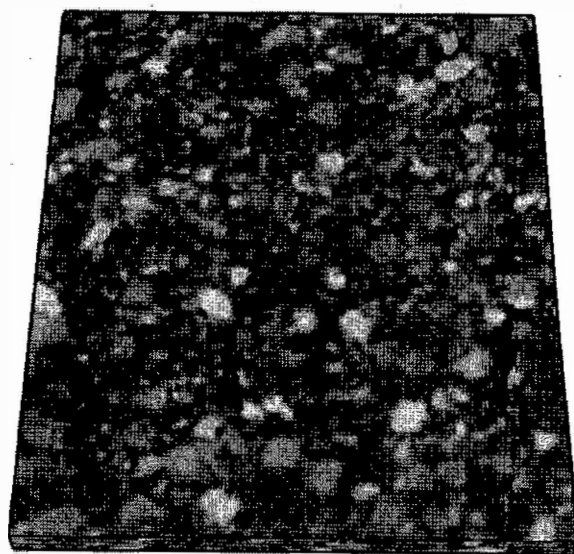

Dintel del revestimiento con el azulejo del granito:

En su kit de la chimenea usted encontrara 5 pedazos de azulejo del granito 6' x6". El granito es ser appliedto la cara del dintel concreto (revestimiento lateral pulido hacia fuera) en la tapa de la caja del fuego usando el pegamento concreto. Cerciorese de que usted utilice un pegamento del muro de contencion que no sea afectado por el calor de la caja del fuego.

Nota: Hay 6 pedazos de azulejo del granito 6' x6" en su kit tambien, estos es para la adiccion de cajas de madera si son una parte de su instalacion.

PRE-CUT Cambridge Pre-Packaged/ Pre-Cut MaytRx Fireplace Kit

2024

Apply concrete adhesive being careful not to put too much adhesive to the point it migrates out of the joints between the tile. Firmly press all tiles into position. It will be necessary to brace up the bottom of the tile to prevent them from moving while the adhesive is curing. Refer to the photos below. Once the tiles are set, leave the bracing in place for 24 hours to allow the adhesive proper time to cure. Wait 2 days after the tile installation before making a fire in your new fireplace.

Note: The first time you use your fireplace, light a small fire for the first 8 hours of use so you properly season the inner fire lining of your fire box. Failure to do so can void the warranty.

Aplique el pegamento concreto que tiene cuidado de no poner demasiado pegamento al punto que emigra de los empalmes entre el azulejo. Presione firmemente todos los azulejos en la posición. Será necesario apoyar encima de la parte inferior del azulejo para evitar que se muevan mientras que el pegamento esta curando. Refiera a las fotos abajo. Una vez que se fijan los azulejos, deje apoyar en el Ingar por 24 horas para dar un plazo de la época apropiada adhesiva de curar. Espere 2 días después de la instalación del azulejo antes de hacer un fuego en su nueva chimenea. Nota: La primera vez que usted utiliza su chimenea, encienda un pequeño fuego para las primeras 8 horas de uso que usted sazona tan correctamente la guarnición interna del fuego de su caja del fuego. La falta de hacer tan puede anular la garantía

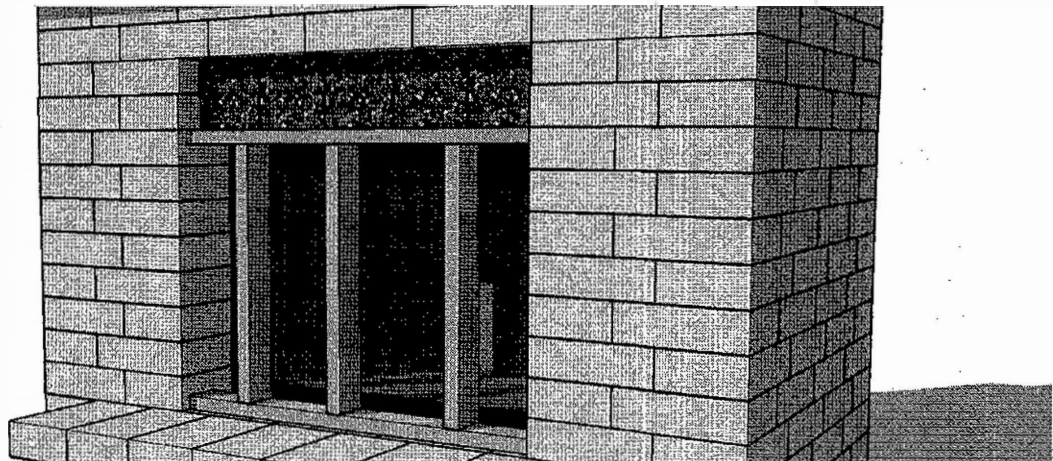
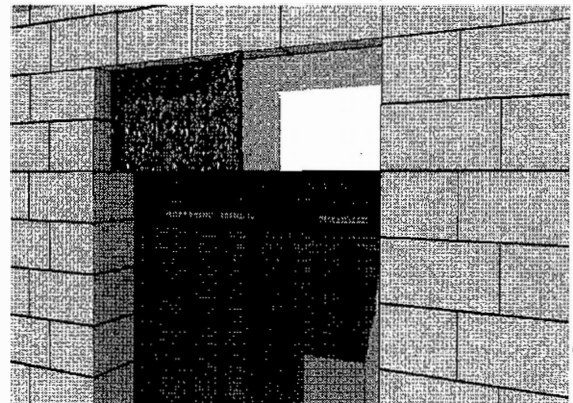
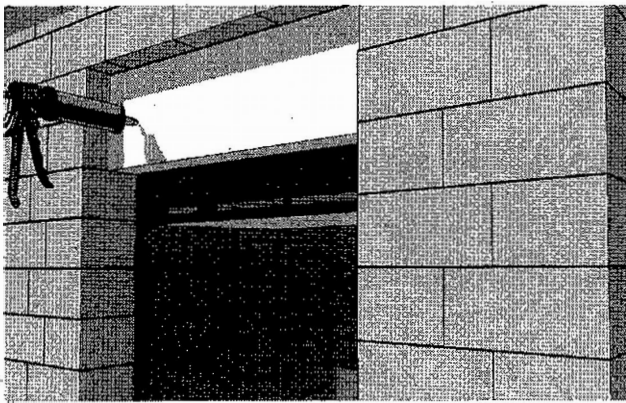

VIEWS

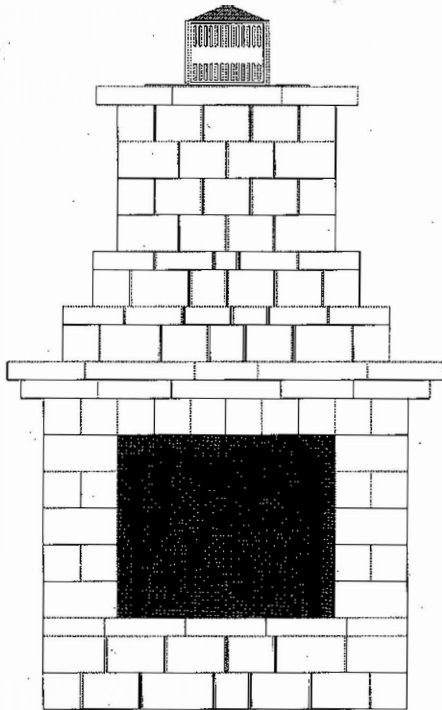

FRONT

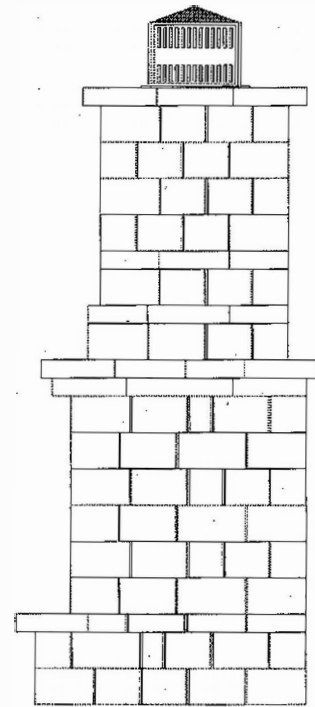

RIGHT

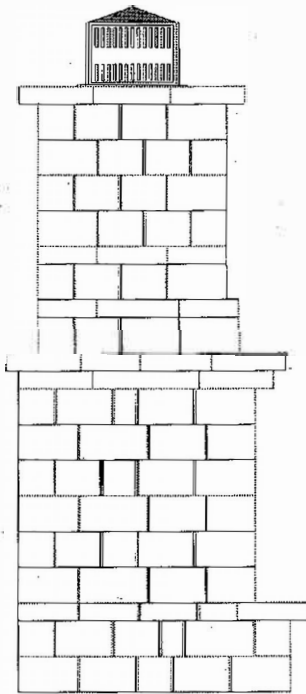

LEFT

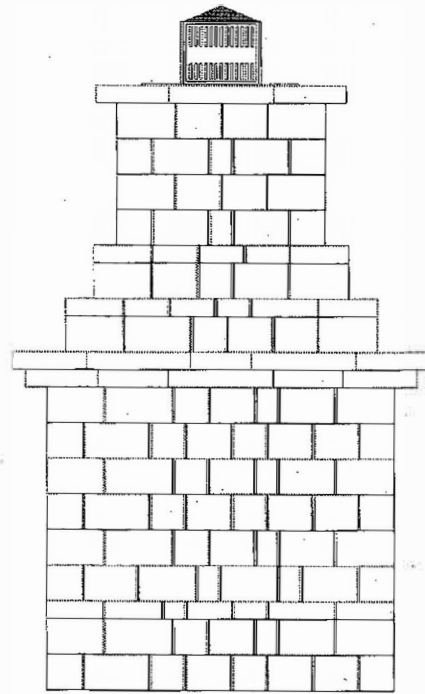

BACK